

# Gear pump with magnetic coupling

Original Operating  
Manual

VGP H1...VGSP H12,  
MAX<sup>®</sup> M0...M8 series



Version BA-2014.01  
Print-No. 01/14

Verder Deutschland GmbH & Co. KG  
Retsch-Allee 1 - 5  
42781 Haan  
Germany  
Phone: +49 (0) 2104 2333-200  
Fax: +49 (0) 2104 2333-299  
E-Mail: [info@verder.de](mailto:info@verder.de)  
Internet: [www.verder.de](http://www.verder.de)

We reserve the right to make technical changes.

## Table of contents

<b>1 About this document</b>	5	5.3.2 Specifying nominal diameters	19
1.1 Target groups	5	5.3.3 Specifying pipe lengths	19
1.2 Other applicable documents	5	5.3.4 Optimizing changes in cross-section and direction	19
1.3 Warnings and symbols	6	5.3.5 Discharging leaks	19
<b>2 Safety</b>	7	5.3.6 Avoiding excessive pressure	19
2.1 Intended use	7	5.3.7 Providing safety and control devices (recommended)	20
2.2 General safety instructions	7	5.4 Connecting the pipes	20
2.2.1 Product safety	7	5.4.1 Keeping the pipes clean	20
2.2.2 Obligations of the operating company	7	5.4.2 Installing auxiliary piping	20
2.2.3 Obligations of personnel	8	5.4.3 Installing the suction pipe	20
2.3 Specific hazards	8	5.4.4 Installing the pressure pipe	21
2.3.1 Hazardous pumped liquids	8	5.5 Electrical connection	21
2.3.2 Magnetic field	8	5.5.1 Connecting the motor	21
<b>3 Layout and function</b>	9	5.5.2 Checking the direction of rotation	21
3.1 Label	9	<b>6 Operation</b>	22
3.2 Pump key	10	6.1 Putting the pump into service for the first time	22
3.2.1 VGP series	10	6.1.1 Removing the preservative	22
3.2.2 MAX series	12	6.1.2 Setting the safety valve	22
3.3 Construction	13	6.1.3 Preparing auxiliary systems (if available)	22
3.4 Bearings and lubrication	14	6.1.4 Filling and bleeding	22
3.5 Shaft seals	14	6.1.5 Checking the direction of rotation	22
3.5.1 Magnetic coupling	14	6.1.6 Switching on	23
3.5.2 Mechanical seal	14	6.1.7 Switching off	23
3.5.3 Stuffing box	14	6.2 Operation	24
<b>4 Transport, storage and disposal</b>	15	6.2.1 Switching on	24
4.1 Transport	15	6.2.2 Switching off	24
4.1.1 Unpacking and inspection on delivery	15	6.3 Shutting down the pump	25
4.1.2 Lifting	15	6.4 Start-up following a shutdown period	25
4.2 Treatment for storage	16	6.5 Operating the stand-by pump	25
4.2.1 Applying preservative to the inside	16	<b>7 Maintenance</b>	26
4.2.2 Applying preservative to the outside	16	7.1 Inspections	26
4.3 Storage	16	7.2 Maintenance	27
4.4 Removing the preservative	17	7.2.1 Mechanical seals	27
4.5 Disposal	17	7.2.2 Stuffing box	27
<b>5 Setup and connection</b>	18	7.2.3 Cleaning the pump	27
5.1 Preparing the setup	18	7.3 Repairs	27
5.1.1 Check operating conditions	18	7.3.1 Dismounting the pump	27
5.1.2 Preparing the installation site	18	7.3.2 Returning the pump to the manufacturer	28
5.1.3 Preparing the foundation and surface	18	7.3.3 Installing	28
5.1.4 Removing the preservative	18	7.4 Ordering spare parts	28
5.2 Setup	18	<b>8 Troubleshooting</b>	29
5.3 Planning the pipes	19	8.1 Pump malfunctions	29
5.3.1 Specifying supports and flange connections	19	<b>9 Appendix</b>	32
		9.1 Sectional drawings	32

9.1.1 VGP series .....	32
9.1.2 MAX <sup>®</sup> series .....	34
9.1.3 Version with mechanical seal .....	37
9.1.4 Versions .....	39
9.2 Technical specifications .....	40
9.2.1 Pump data .....	40
9.2.2 Ambient conditions .....	40
9.2.3 Parameters for auxiliary systems .....	40
9.2.4 Sound pressure level .....	40
9.2.5 Tightening torques .....	41
9.2.6 Preservatives .....	41
9.2.7 Cleaning agents .....	41
9.3 Performance curves .....	42
9.4 Clearance certificate .....	48
9.5 Declaration of conformity according to EC Machine Directive .....	49

## List of figures

Fig. 1	ATEX name plate .....	9
Fig. 2	Pump key (VGP series) .....	10
Fig. 3	Pump key (MAX series) .....	12
Fig. 4	Construction .....	13
Fig. 5	Fastening the lifting gear to the pump unit with base plate .....	15
Fig. 6	Fastening the lifting gear to the pump without base plate .....	15
Fig. 7	Straight pipe lengths upstream and downstream of the pump (recommended) .....	19
Fig. 8	Sectional drawing of magnetic coupling (VGP series) .....	33
Fig. 9	Sectional drawing of pump (VGP series) .....	33
Fig. 10	Sectional drawing of magnetic coupling (MAX <sup>®</sup> series) .....	35
Fig. 11	Sectional drawing of pump (MAX <sup>®</sup> series) .....	36
Fig. 12	Sectional drawing of version with mechanical seal (MAX <sup>®</sup> series) .....	38
Fig. 13	Version with stuffing box .....	39
Fig. 14	Version with external mechanical seal .....	39
Fig. 15	Version with double mechanical seal .....	39

## List of tables

Tab. 1	Target groups and their duties .....	5
Tab. 2	Other applicable documents and their purpose .....	5
Tab. 3	Warnings and consequences of disregarding them .....	6
Tab. 4	Symbols and their meaning .....	6
Tab. 5	Explanation of the ATEX plate .....	9
Tab. 6	Pump type code (VGP series) .....	11
Tab. 7	Pump type code (MAX series) .....	12
Tab. 8	Measures to be taken if the pump is shut down .....	25
Tab. 9	Measures depending on the behavior of the pumped liquid .....	25
Tab. 10	Measures for returning the pump .....	28
Tab. 11	Fault number assignment .....	29
Tab. 12	Pump troubleshooting list .....	31
Tab. 13	Designation of components (VGP series) .....	32
Tab. 14	Designation of components (MAX <sup>®</sup> series) .....	34
Tab. 15	Designation of components (MAX <sup>®</sup> series) .....	37
Tab. 16	Designation of components (MAX <sup>®</sup> series) .....	39
Tab. 17	Pump data .....	40
Tab. 18	Operating parameters for blocking medium .....	40
Tab. 19	Operating parameters for sealing medium .....	40
Tab. 20	Tightening torques .....	41
Tab. 21	Cleaning agents .....	41
Tab. 22	Clearance certificate .....	48
Tab. 23	Declaration of conformity according to EC Machine Directive .....	49

# 1 About this document

This manual:

- Is part of the pump
- Applies to the pump series mentioned above
- Describes safe and appropriate operation during all operating phases

## 1.1 Target groups

Target group	Duty
Operating company	<ul style="list-style-type: none"> <li>▶ Keep this manual available at the site of operation of the equipment, including for later use.</li> <li>▶ Ensure that personnel read and follow the instructions in this manual and the other applicable documents, especially all safety instructions and warnings.</li> <li>▶ Observe any additional rules and regulations referring to the system.</li> </ul>
Qualified personnel, fitter	<ul style="list-style-type: none"> <li>▶ Read, observe and follow this manual and the other applicable documents, especially all safety instructions and warnings.</li> </ul>





Tab. 1 Target groups and their duties

## 1.2 Other applicable documents



Document	Purpose
Dimension sheet	Pump dimensions
Sectional drawing	Sectional drawing, part numbers, component designations
Supplier documentation	Technical documentation for vendor parts (e.g. drive)
Declaration of conformity	Conformity with standards, contents of the declaration of conformity (→ 9.5 Declaration of conformity according to EC Machine Directive, Page 49).

Tab. 2 Other applicable documents and their purpose

### 1.3 Warnings and symbols

Warning	Risk level	Consequences of disregarding the warning
	Immediate acute risk	Death, serious injuries
	Potential acute risk	Death, serious injuries
	Potentially hazardous situation	Minor bodily harm
	Potentially hazardous situation	Material damage

Tab. 3 Warnings and consequences of disregarding them

Symbol	Meaning
	Safety warning sign ▶ Take note of all information highlighted by the safety warning sign and follow the instructions to avoid injury or death.
▶	Instruction
1. , 2. , etc.	Multiple-step instructions
✓	Precondition
→	Cross reference
	Information, notes

Tab. 4 Symbols and their meaning

## 2 Safety

 The manufacturer does not accept any liability for damages caused by disregarding the entire documentation.

### 2.1 Intended use

- Only use the pump for pumping the allowed pumped liquids (→ 9.2 Technical specifications, Page 40).
- Adhere to the operating limits.
- Avoid dry running:
  - Make sure the pump is only operated with pumped liquid, and never operated continuously without it.
- Avoid cavitation:
  - Fully open the suction-side fitting and do not use it to adjust the flow rate.
  - Open the pressure-side fitting completely.
- Avoid damage to the motor:
  - Note the maximum permissible number of times the motor can be switched on per hour (→ manufacturer's specifications).
- Consult the manufacturer about any other use of the pump.
- Pumps delivered without a motor must be assembled into a pump unit according to the provisions of EC Machine Directive 2006/42/EC.

#### Prevention of obvious misuse (examples)

- Note the operating limits of the pump with regard to temperature, pressure, viscosity, flow rate and motor speed. (→ 9.2 Technical specifications, Page 40).
- When using auxiliary systems, ensure there is a continuous supply of the appropriate operating medium.
- Do not operate the pump while the pressure-side fitting is closed.
- Pumps may not be used with foodstuffs if they have not been adapted accordingly. Usage with foodstuffs must be agreed with the manufacturer.
- Only select the setup type according to this operating manual. For example, the following are not allowed:
  - Hanging base plate pumps in the pipe
  - Overhead installation
  - Installation in the immediate vicinity of extreme heat or cold sources
  - Installation too close to the wall

### 2.2 General safety instructions

 Observe the following regulations before carrying out any work.

#### 2.2.1 Product safety

The pump has been constructed according to the latest technology and recognized technical safety rules. Nevertheless, operation of the pump can still put the life and health of the user or third parties at risk or damage the pump or other property.

- Keep this manual and all other applicable documents complete, legible and accessible to personnel at all times.
- Refrain from any procedures and actions that would pose a risk to personnel or third parties.
- In the event of any safety-relevant malfunctions, shut down the pump immediately and have the malfunction corrected by the personnel responsible.
- In addition to the entire documentation for the product, comply with statutory or other safety and accident-prevention regulations and the applicable standards and guidelines in the country where the pump is operated.

#### 2.2.2 Obligations of the operating company

##### Safety-conscious operation

- Only operate the pump if it is in perfect technical condition and only use it as intended, remaining aware of safety and risks, and adhere to the instructions in this manual.
- Ensure that the following safety aspects are observed and monitored:
  - Intended use
  - Statutory or other safety and accident-prevention regulations
  - Safety regulations governing the handling of hazardous substances
  - Applicable standards and guidelines in the country where the pump is operated
- Make personal protective equipment available.

##### Qualified personnel

- Make sure all personnel tasked with work on the pump have read and understood this manual and all other applicable documents, especially the safety, maintenance and repair information, before they start any work.
- Organize responsibilities, areas of competence and the supervision of personnel.

- Ensure that all work is carried out by specialist technicians only:
  - Fitting, repair and maintenance work
  - Work on the electrical system
- Make sure that trainee personnel only work on the pump under the supervision of specialist technicians.
- Persons who have an implanted pacemaker:
  - Must stay away from the pump with magnetic coupling and parts of the magnetic coupling
  - May not work on or with any of the magnetic parts

### Safety equipment

- Provide the following safety equipment and verify its functionality:
  - For hot, cold and moving parts: on-site safety guards for the pump
  - For possible electrostatic charges: provide the necessary grounding
  - If there is no pressure relief valve in the pump: Provide a suitable pressure relief valve on the pressure side between the pump and the first shut-off device

### Warranty

- Obtain the manufacturer's approval prior to carrying out any modifications, repairs or alterations during the warranty period.
- Only use genuine parts or parts that have been approved by the manufacturer.

### 2.2.3 Obligations of personnel

- All directions given on the pump must be followed (and kept legible), e.g. the flow direction arrow and the markings for fluid connections.
- Pump, coupling guard and components:
  - Do not step on them or use as a climbing aid
  - Do not use them to support boards, ramps or beams
  - Do not use them as a fixing point for winches or supports
  - Do not use them for storing paper or similar materials
  - Do not use hot pump or motor components as a heating point
  - Do not de-ice using gas burners or similar tools
- Do not remove the safety guarding for hot, cold or moving parts during operation.
- Use personal protective equipment whenever necessary.
- Only carry out work on the pump while it is not running.
- Isolate the motor from its supply voltage and secure it against being switched back on again when carrying out any fitting or maintenance work.
- Reinstall the safety equipment on the pump as required by regulations after any work on the pump.
- With an implanted pacemaker:
  - Stay at least 1 meter away from the pump with magnetic coupling or parts of the magnetic coupling.
  - Do not work with or on the magnetic parts.

## 2.3 Specific hazards

### 2.3.1 Hazardous pumped liquids

- Follow the safety regulations for handling hazardous substances when handling hazardous (e.g. hot, flammable, poisonous or potentially harmful) pumped liquids.
- Use personal protective equipment when carrying out any work on the pump.

### 2.3.2 Magnetic field

The magnetic field of the magnetic coupling can destroy products that are sensitive to magnets. These include:

- Pacemakers
- Plastic identity cards with magnetic strips
- Credit and check cards
- Electric, electronic and precision mechanical devices (such as mechanical and digital clocks, pocket calculators, hard disks)



## 3 Layout and function

VGP and MAX<sup>®</sup> series gear pumps have been constructed for the low-pulsation pumping of non-corrosive pumped liquids. The MAX<sup>®</sup> series is suitable for higher pressures.

### 3.1 Label

 The serial number and the pump key are given on the name plate.

#### ATEX code

 For ATEX certification the following plate must be fixed to the pump.

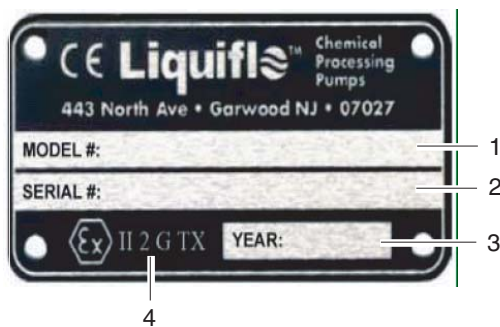

Fig. 1 ATEX name plate

- 1 Pump type
- 2 Serial number
- 3 Year of manufacture
- 4 ATEX information

Information	Meaning
Group II	Explosive environment
Category 2	Provides a high degree of protection. The atmosphere is likely to be explosive
Category 3	Provides a medium degree of protection. The atmosphere is unlikely to be explosive
D	Dust
G	Gas
TX	Surface temperature, depending on the fluid

Tab. 5 Explanation of the ATEX plate

### 3.2 Pump key

#### 3.2.1 VGP series

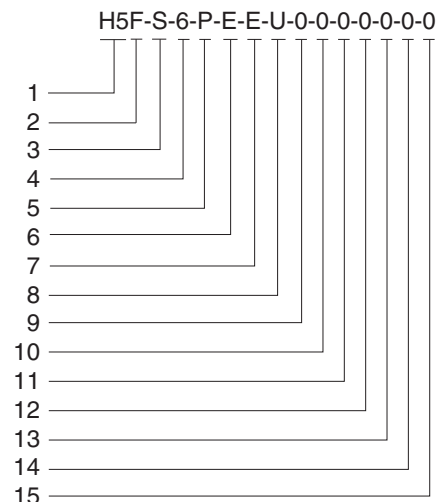

Fig. 2 Pump key (VGP series)

Position	Meaning	
1	Size	
2	Version	
	F	Full flow
	R	Reduced flow
3	Housing material	
	S	316 SS NPT
	L	316 SS flanged
	X	316 SS BSPT
	H	Alloy-C NPT
	C	Alloy-C flanged
	Y	Alloy-C BSPT
4	Material of driving gearwheel	
	1	Alloy-C
	3	Teflon
	6	316 SS
	P	PEEK

Position	Meaning	
5	Material of driven gearwheel	
	1	Alloy-C
	3	Teflon
	6	316 SS
	8	Ryton
	P	PEEK
6	Wear plate material	
	3	Teflon
	4	Ceramic
	E	Carbon 60
	P	PEEK
7	Bearing material	
	3	Teflon
	B	SiC
	E	Carbon 60
	P	PEEK
8	Outer magnet hole	
	0	0.625" (NEMA 56C/56HC)
	1	0.875" (NEMA 143/145TC)
	2	14 mm (IEC 71 - B5)
	3	19 mm (IEC 80 - B5)
	4	24 mm (IEC90 - B5)
	5	1.125" (NEMA 182/184TC)
	6	1.375" (NEMA 213/215TC)
7	1.625" (NEMA 254/256TC)	
8	Seal	
	U	Single mechanical seal, carbon-ceramic
	S	Single mechanical seal, Teflon-ceramic
	F	Double mechanical seal, carbon-ceramic
	H	Double mechanical seal, Teflon-ceramic
	L	Packing, Teflon
	R	Packing, Grafoil

Position	Meaning	
9	Bearing flushing	
	0	Standard housing
	1	External bearing flushing
	2	Internal bearing flushing
10	Shaft coating	
	0	Housing material
	1	Ceramic
	2	Tungsten carbide
11	O-rings	
	0	Teflon
	6	316 SS/PFA enclosed
	B	Buna-N
	E	EPDM
	V	Viton
	K	Kalrez
12	Snap ring	
	0	Housing material
13	Bearing pin	
	0	Teflon
	1	Alloy-C
	6	316 SS
14	Adapter version	
	0	Short-coupled (NEMA 56C/56HC)
	1	Short-coupled (NEMA 143/145TC)
	2	Short-coupled (IEC 71 - B5)
	3	Short-coupled (IEC 80 - B5)
	4	Short-coupled (IEC 90 - B5)
	5	Short-coupled (NEMA 182/184TC)
	6	Short-coupled (NEMA 213/215TC)
	7	Short-coupled (NEMA 254/256TC)
	9	Long-coupled
14	Magnetic coupling torque	
	U	75 inch/Ib = 8.5 Nm
	B	120 inch/Ib = 13.5 Nm
	V	200 inch/Ib = 22.5 Nm
	K	325 inch/Ib = 36.6 Nm
	J	650 inch/Ib = 73.3 Nm

Position	Meaning	
15	Separating can	
	S	Standard
	D	Double-walled

Tab. 6 Pump type code (VGP series)

3.2.2 MAX series

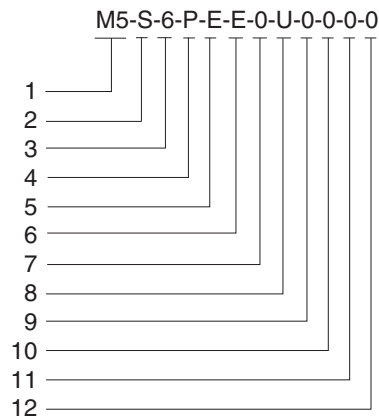

Fig. 3 Pump key (MAX series)

Position	Meaning	
1	Size	
2	Housing material	
	S	316 SS NPT
	L	316 SS flanged
	X	316 SS BSPT
	T	Titanium NPT
	Z	Titanium BSPT
3	Material of driving gearwheel	
	4	Titanium
	6	316 SS
	9	17-4 PH SS integral gear shaft
	P	PEEK
4	Material of driven gearwheel	
	4	Titanium
	6	316 SS
	9	17-4 PH SS integral gear shaft
	P	PEEK
5	Wear plate material	
	3	Teflon
	4	Ceramic
	E	Carbon 60
	P	PEEK

Position	Meaning	
6	Bearing material	
	B	SiC
	E	Carbon 60
	P	PEEK
7	Outer magnet hole	
	0	0.625" (NEMA 56C/56HC)
	1	0.875" (NEMA 143/145TC)
	2	14 mm (IEC 71 - B5)
	3	19 mm (IEC 80 - B5)
	4	24 mm (IEC90 - B5)
	5	1.125" (NEMA 182/184TC)
8	Seal	
	U	Single mechanical seal, carbon-ceramic
	F	Double mechanical seal, carbon-ceramic
	0	Magnetic coupling (sealless)
9	Bearing flushing	
	0	Standard housing
	2	Internal bearing flushing
10	Shaft coating	
	0	316 SS (uncoated)
	1	Ceramic
	2	Tungsten carbide
	3	17-4 PH SS integral gear shaft
11	O-rings	
	0	Teflon - Viton
	V	Viton - Viton
	T	Teflon - Kalrez
	K	Kalrez - Kalrez
12	Magnetic coupling torque	
	U	75 inch/Ib = 8.5 Nm
	B	120 inch/Ib = 13.5 Nm
	V	200 inch/Ib = 22.5 Nm
	K	325 inch/Ib = 36.6 Nm
	J	650 inch/Ib = 73.3 Nm

Tab. 7 Pump type code (MAX series)

## 3.3 Construction

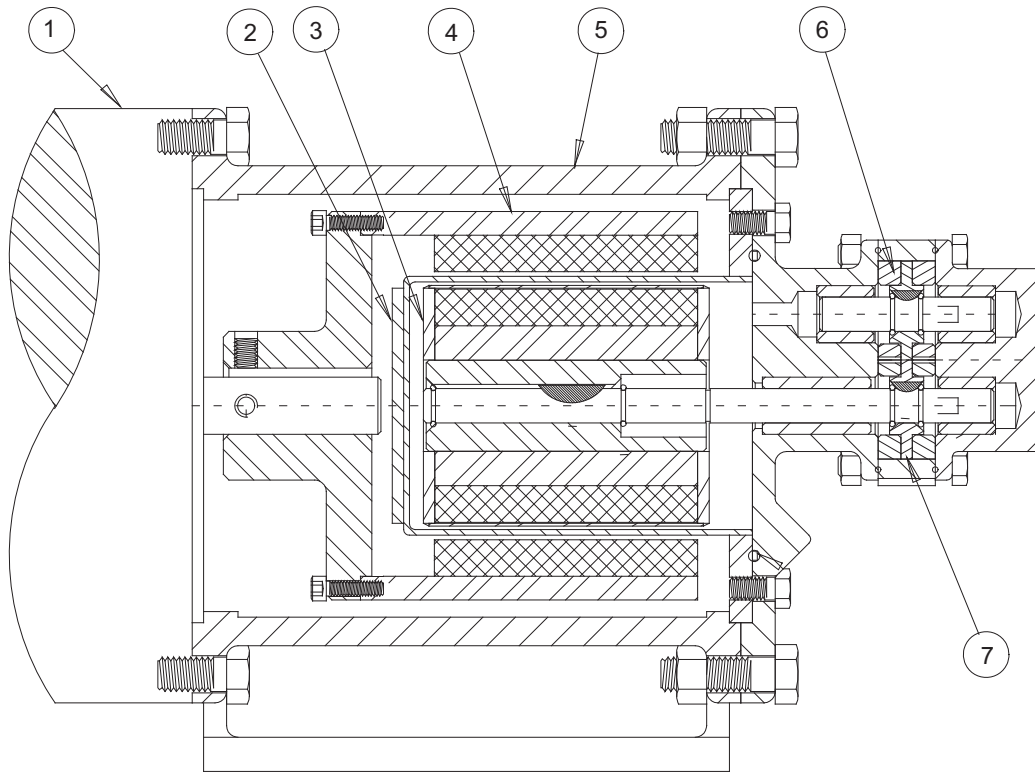



Fig. 4 Construction

- |                  |                    |                     |
|------------------|--------------------|---------------------|
| 1 Motor          | 4 Outer magnet     | 7 Driving gearwheel |
| 2 Separating can | 5 Adapter          |                     |
| 3 Inner magnet   | 6 Driven gearwheel |                     |

### 3.4 Bearings and lubrication

Pump: Internal sleeve bearing lubricated by pumped liquid

### 3.5 Shaft seals

 Only one of the following shaft seals is fitted.

#### 3.5.1 Magnetic coupling

Hermetically sealed magnetic coupling

#### 3.5.2 Mechanical seal

 Mechanical seals have functional leaks.

- Single mechanical seal, carbon-ceramic
- Double mechanical seal with external blocking

#### 3.5.3 Stuffing box

 Stuffing boxes must always leak slightly to carry the frictional heat away.

- Stuffing box with Teflon packing
- Stuffing box with Grafoil packing

## 4 Transport, storage and disposal

### 4.1 Transport

**⚠ DANGER**

**Risk of death and material damage due to magnetic field!**

- ▶ Make sure that personnel who have a pacemaker fitted do not perform any work on the pump.
- ▶ Secure the work area. If necessary isolate the area:
  - Make sure that personnel with pacemakers keep a safe distance of at least 1 meter.
  - Make sure that no magnetizable metal parts can be attracted by the magnetic coupling of the pump.
  - Make sure that parts of the magnetic coupling cannot be attracted by the magnetizable metal parts.
- ▶ Keep all magnetically-sensitive objects at a safe distance of at least 150 mm from the magnetic coupling.

#### 4.1.1 Unpacking and inspection on delivery

1. Unpack the pump/unit on delivery and inspect it for transport damage.
2. Report any transport damage to the manufacturer immediately.
3. Dispose of packaging material according to local regulations.

#### 4.1.2 Lifting

**⚠ DANGER**

**Death or crushing of limbs caused by falling loads!**

- ▶ Use lifting gear appropriate for the total weight to be transported.
- ▶ Fasten the lifting gear as shown in the following illustrations.
- ▶ Never fasten the lifting gear onto the motor eyebolt (unless used as a safety device against tipping over for units with a high center of gravity).
- ▶ Do not stand under suspended loads.

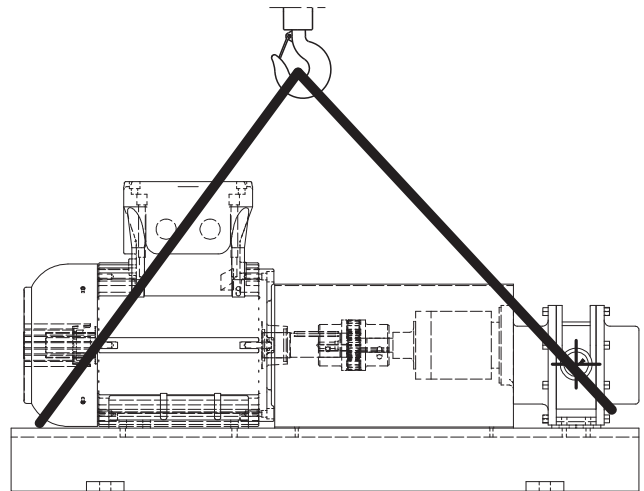

Fig. 5 Fastening the lifting gear to the pump unit with base plate

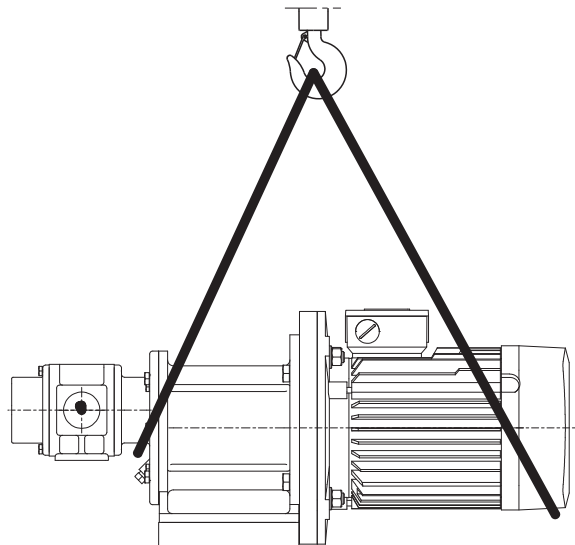



Fig. 6 Fastening the lifting gear to the pump without base plate

- ▶ Lift the pump/pump unit properly.

## 4.2 Treatment for storage

-  The pump has not been treated for storage at the factory.  
Treatment is not necessary for non-rusting materials.

### WARNING

#### Danger of poisoning or contamination due to preservatives!

- ▶ Only use a preservative which is compatible with the pumped liquid (→ 9.2.7 Cleaning agents, Page 41).

### NOTE

#### Material damage due to inappropriate treatment for storage!

- ▶ Treat the pump properly, inside and outside, for storage.

#### 4.2.1 Applying preservative to the inside

1. Close the suction connection with a blank flange.
2. Fill the pump via the pressure connection with preservative (e.g. RUST-BAN 335).
3. Turn the shaft slowly against the pump's sense of rotation.
4. Continue filling and turning until no bubbles emerge from the pressure connection.
5. Close the pressure connection with a blank flange.
6. Every 6 months:
  - Renew the preservative if necessary.

#### 4.2.2 Applying preservative to the outside

1. Apply preservative to all bare metal parts.
2. Every 6 months:
  - Renew the preservative if necessary.

## 4.3 Storage

### DANGER

#### Risk of death and material damage due to magnetic field!

- ▶ Make sure that personnel who have a pacemaker fitted do not perform any work on the pump.
- ▶ Secure the work area. If necessary isolate the area:
  - Make sure that personnel with pacemakers keep a safe distance of at least 1 meter.
  - Make sure that no magnetizable metal parts can be attracted by the magnetic coupling of the pump.
  - Make sure that parts of the magnetic coupling cannot be attracted by the magnetizable metal parts.
- ▶ Keep all magnetically-sensitive objects at a safe distance of at least 150 mm from the magnetic coupling.

### NOTE

#### Material damage due to inappropriate storage!

- ▶ Treat and store the pump properly.
1. Seal all openings with blank flanges, blind plugs or plastic covers.
  2. Make sure the storage room meets the following conditions:
    - Dry
    - Frost-free
    - Vibration-free
    - Dust-free
    - Ambient conditions are met (→ 9.2.2 Ambient conditions, Page 40).
  3. Turn the shaft once a month.



## 4.4 Removing the preservative

 Only necessary for pumps treated for storage.

---

### NOTE

**High water pressure or spray water can damage bearings!**

- ▶ Do not clean bearing areas with a water or steam jet.

---

### NOTE

**Damage to seals due to wrong cleaning agents!**

- ▶ Ensure the cleaning agent does not corrode the seals.
1. Choose the cleaning agent to suit the area of application (→ 9.2.7 Cleaning agents, Page 41).
  2. Remove the preservative from all bare internal parts of the pump.
  3. Dispose of cleaning agents in accordance with local regulations.
  4. For storage times in excess of 6 months:
    - Replace the elastomer parts made of EP rubber (EPDM).
    - Check all elastomer parts (O-rings, shaft seals) for proper elasticity and replace them if necessary.

## 4.5 Disposal

 Plastic parts can be contaminated by poisonous or radioactive pumped liquids to such an extent that cleaning will be insufficient.

 **DANGER**

**Risk of death and material damage due to magnetic field!**

- ▶ Make sure that personnel who have a pacemaker fitted do not perform any work on the pump.
- ▶ Secure the work area. If necessary isolate the area:
  - Make sure that personnel with pacemakers keep a safe distance of at least 1 meter.
  - Make sure that no magnetizable metal parts can be attracted by the magnetic coupling of the pump.
  - Make sure that parts of the magnetic coupling cannot be attracted by the magnetizable metal parts.
- ▶ Keep all magnetically-sensitive objects at a safe distance of at least 150 mm from the magnetic coupling.

 **WARNING**

**Risk of poisoning and environmental damage by the pumped liquid or oil!**

- ▶ Use personal protective equipment when carrying out any work on the pump.
  - ▶ Prior to the disposal of the pump:
    - Collect and dispose of any escaping pumped liquid or oil in accordance with local regulations.
    - Neutralize residues of pumped liquid in the pump.
    - Removing the preservative (→ 4.4 Removing the preservative, Page 17).
  - ▶ Remove the plastic parts and dispose of them in accordance with local regulations.
- 
- ▶ Dispose of the pump in accordance with local regulations.

## 5 Setup and connection

### DANGER

#### Risk of death and material damage due to magnetic field!

- ▶ Make sure that personnel who have a pacemaker fitted do not perform any work on the pump.
- ▶ Secure the work area. If necessary isolate the area:
  - Make sure that personnel with pacemakers keep a safe distance of at least 1 meter.
  - Make sure that no magnetizable metal parts can be attracted by the magnetic coupling of the pump.
  - Make sure that parts of the magnetic coupling cannot be attracted by the magnetizable metal parts.
- ▶ Keep all magnetically-sensitive objects at a safe distance of at least 150 mm from the magnetic coupling.

### NOTE

#### Material damage due to distortion or passage of electrical current in the bearing!

- ▶ Do not make any structural modifications to the pump unit or pump casing.
- ▶ Do not carry out any welding work on the pump unit or pump casing.

### NOTE

#### Material damage caused by dirt!

- ▶ Do not remove any covers or transport and screw plugs until immediately before connecting the pipes to the pump.

## 5.1 Preparing the setup

### 5.1.1 Check operating conditions

1. Ensure the pump data is adhered to (→ 9.2.1 Pump data, Page 40).
2. Make sure the required ambient conditions are fulfilled (→ 9.2.2 Ambient conditions, Page 40).

### 5.1.2 Preparing the installation site

- ▶ Ensure the installation site meets the following conditions:
  - Pump is freely accessible from all sides
  - Sufficient space for the installation/removal of the pipes and for maintenance and repair work, especially for the removal and installation of the pump and the motor
  - Pump not exposed to external vibrations (damage to bearings)
  - Frost protection

### 5.1.3 Preparing the foundation and surface

- ▶ Make sure the foundation and surface fulfill the following requirements:
  - Level
  - Clean (no oil, dust or other impurities)
  - Capable of bearing the weight of the pump unit and all operating forces
  - The pump is stable and cannot tip over
  - With concrete foundation: Standard concrete of strength class B 25

### 5.1.4 Removing the preservative

- ▶ If the pump is to be put into operation immediately after setup and connection: Remove the preservative prior to installation (→ 4.4 Removing the preservative, Page 17).

## 5.2 Setup

1. Lift the pump unit (→ 4.1 Transport, Page 15).
2. Place down the pump unit at its installation location.
3. Screw in the fastening bolts on the foot of the motor and tighten them (→ 9.2.5 Tightening torques, Page 41).

## 5.3 Planning the pipes

### 5.3.1 Specifying supports and flange connections

#### NOTE

**Material damage due to excessive forces and torques exerted by the piping on the pump!**

► Do not exceed the permissible values (→ flange loads according to EN ISO 14847).

1. Calculate the pipe forces, taking every possible operating condition into account:
  - Cold/warm
  - Empty/full
  - Depressurized/pressurized
  - Positional changes of the flanges
2. Ensure the pipe supports have permanent low-friction properties and do not seize up due to corrosion.

### 5.3.2 Specifying nominal diameters

 Keep the flow resistance in the pipes as low as possible.

1. Make sure the nominal suction pipe diameter is  $\geq$  to the nominal suction connection diameter.
  - Make sure the flow rate is below 1.5 m/s
2. Make sure the nominal pressure pipe diameter is  $\geq$  to the nominal outlet connection diameter.
  - Make sure the flow rate is below 3.0 m/s

### 5.3.3 Specifying pipe lengths

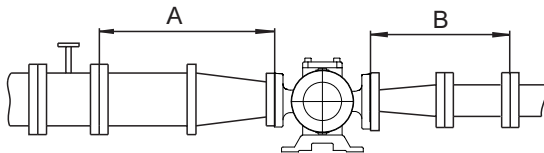



Fig. 7 Straight pipe lengths upstream and downstream of the pump (recommended)

A > 5 x nominal suction pipe diameter

B > 5 x nominal pressure pipe diameter

► Maintain the recommended minimum values when installing the pump.

 Suction side: Shorter pipes are possible but may restrict the hydraulic performance.

Pressure side: Shorter pipes are possible but can result in increased operating noise.

### 5.3.4 Optimizing changes in cross-section and direction

1. Avoid bending radii of less than 1.5 times the nominal pipe diameter.
2. Avoid abrupt changes of cross-section and direction along the piping.

### 5.3.5 Discharging leaks

#### WARNING

**Risk of injury and poisoning due to hazardous pumped liquids!**

► Safely collect any leaking pumped liquid, then discharge and dispose of it in accordance with environmental regulations.

1. Provide equipment for collecting and discharging leaking liquids.
2. Ensure the free discharge of leaking liquids.

### 5.3.6 Avoiding excessive pressure

#### WARNING

**Risk of injury due to excessive pressure!**

► If there is no pressure relief valve in the pump: Provide a suitable pressure relief valve in the pressure line.

1. Observe the operating instructions of the manufacturer.
2. Make sure the factory setting of the pressure relief valve meets the requirements of the system.
3. Do **not** feed the return flow of the pressure relief valve directly back into the suction pipe.

### 5.3.7 Providing safety and control devices (recommended)

#### Avoid impurities

1. Install a dirt trap in the suction pipe (mesh size  $\leq 25 \mu\text{m}$ ).
2. To monitor impurities, install a differential pressure gauge with contact pressure gauge.

#### Making provisions for isolating and shutting off pipes

 For maintenance and repair work.

- Provide shut-off devices in the suction and pressure pipes.

#### Allowing measurement of the operating conditions

1. Provide pressure gauges for measurements in the suction and pressure pipes.
2. Provide for suction-side temperature measurements.

#### Monitoring leaks

 Only necessary for hot or hazardous pumped liquids.

1. Provide leak monitoring equipment.
2. Safely collect major leakages (e.g. following a seal malfunction) and dispose of them.

## 5.4 Connecting the pipes

### 5.4.1 Keeping the pipes clean

#### NOTE

#### Material damage due to impurities in the pump!

- Make sure no impurities can enter the pump.

1. Flush all pipe parts and fittings prior to assembly.
2. Make sure no seals protrude inwards.
3. Remove any blank flanges, plugs, protective foils and/or protective paint from the flanges.
4. On welded pipes: Remove the welding beads.

### 5.4.2 Installing auxiliary piping

 Observe the manufacturer's specifications for any auxiliary operating systems which are present.

1. With a single mechanical seal on the inside:
  - Establish what pressure is exerted on the mechanical seal (high pressure – low pressure)
  - Remove the plug on the mechanical seal housing to the high pressure side
2. With a single mechanical seal on the inside and when used in the vacuum system:
  - Connect the discharge pipe with regulation valve to the mechanical seal housing so that they are stress-free and do not leak
3. With a double mechanical seal on the inside:
  - Remove both plugs on the mechanical seal housing
4. Connect the auxiliary pipes to the auxiliary connections so that they are stress-free and do not leak (→ setup drawing).
5. Avoid air pockets: Run the pipes with a continuous slope up to the pump.

### 5.4.3 Installing the suction pipe

1. Make sure that the thread of the suction pipe and suction connection correspond.
2. Remove the transport and screw plugs from the pump.
3. Always install the suction pipe at an incline:
  - Wrap thread sealant (e.g. Teflon tape) around the thread
  - Screw in the suction pipe at least two turns and max. 5 turns manually
  - Hold the pump head while turning in

#### 5.4.4 Installing the pressure pipe

1. Make sure that the thread of the pressure line and pressure connection correspond.
2. Remove the transport and screw plugs from the pump.
3. Always install the pressure line at an incline:
  - Wrap thread sealant (e.g. Teflon tape) around the thread
  - Screw in the pressure line at least two turns and max. 5 turns manually
  - Hold the pump head while turning in

## 5.5 Electrical connection

 **DANGER**

### Risk of electrocution!

- ▶ Have all electrical work carried out by qualified electricians only.

#### 5.5.1 Connecting the motor

 Follow the instructions of the motor manufacturer.

1. Connect the motor according to the connection diagram.
2. Make sure no danger arises due to electric power.
3. Install an EMERGENCY STOP switch.

#### 5.5.2 Checking the direction of rotation

 This is only possible when the pump starts operation (→ 6.1 Putting the pump into service for the first time, Page 22).

## 6 Operation

### DANGER

#### Risk of death and material damage due to magnetic field!

- ▶ Make sure that personnel who have a pacemaker fitted do not perform any work on the pump.
- ▶ Secure the work area. If necessary isolate the area:
  - Make sure that personnel with pacemakers keep a safe distance of at least 1 meter.
  - Make sure that no magnetizable metal parts can be attracted by the magnetic coupling of the pump.
  - Make sure that parts of the magnetic coupling cannot be attracted by the magnetizable metal parts.
- ▶ Keep all magnetically-sensitive objects at a safe distance of at least 150 mm from the magnetic coupling.

### 6.1 Putting the pump into service for the first time

#### 6.1.1 Removing the preservative

 Only necessary for pumps treated for storage.

- ▶ (→ 4.4 Removing the preservative, Page 17).

#### 6.1.2 Setting the safety valve

- ▶ Make sure the safety valve on the system side meets the requirements of the pump.

#### 6.1.3 Preparing auxiliary systems (if available)

 The manufacturer does not accept any liability for damage caused by installing or using a third-party or unapproved auxiliary system.

#### Sealing systems

1. Ensure that the sealing medium is suitable for mixing with the pumped liquid.
2. Identify the sealing system (→ order data sheet).
3. Install the sealing system (→ manufacturer's specifications).
4. Make sure the parameters required for the installed sealing system are met (→ 9.2.3 Parameters for auxiliary systems, Page 40).
5. Ensure that the permissible container pressure is not exceeded on blocking pressure systems (→ manufacturer's specifications).

#### 6.1.4 Filling and bleeding

- ✓ Auxiliary systems ready for operation

### WARNING

#### Risk of injury and poisoning due to hazardous pumped liquids!

- ▶ Safely collect any leaking pumped liquid and dispose of it in accordance with environmental rules and requirements.

1. Open the suction-side fitting.
2. Fill the pump and suction pipe with pumped liquid until pumped liquid escapes without bubbles.
3. Open the pressure-side fitting.
4. If available: Open the auxiliary systems and check the flow rate.
5. Ensure that no pipe connections are leaking.

#### 6.1.5 Checking the direction of rotation

- ✓ Pump prepared, filled and bled properly

### DANGER

#### Risk of injury due to running pump!

- ▶ Do not touch the running pump.
- ▶ Do not carry out any work on the running pump.
- ▶ Allow the pump to cool down completely before starting any work.

1. Open the pressure-side fitting.
2. Open the suction-side fitting.
3. Switch the motor on and immediately off again.
4. Check whether the flow direction arrow of the pump corresponds with the flow direction.
5. If the sense of rotation is different:
  - Swap two phases (→ 5.5.1 Connecting the motor, Page 21).

### 6.1.6 Switching on

- ✓ Pump set up and connected properly
- ✓ Motor set up and connected properly
- ✓ All connections stress-free and sealed
- ✓ All safety equipment installed and tested for functionality
- ✓ Pump prepared, filled and bled properly

## ⚠ DANGER

### Risk of injury due to running pump or hot pump parts!

- ▶ Do not touch the running pump.
- ▶ Do not carry out any work on the running pump.
- ▶ Allow the pump to cool down completely before starting any work.

## ⚠ DANGER

### Risk of injury and poisoning due to pumped liquid spraying out!

- ▶ Use personal protective equipment when carrying out any work on the pump.

## NOTE

### Risk of cavitation when throttling down the suction flow rate!

- ▶ Fully open the suction-side fitting and do not use it to adjust the flow rate.

## NOTE

### Material damage due to excessive pressure!

- ▶ Do not operate the pump while the pressure-side fitting is closed.

## NOTE

### Material damage caused by dry running!

- ▶ Make sure the pump is filled properly.
1. Open the pressure-side fitting.
  2. Open the suction-side fitting.
  3. Switch on the motor and make sure it is running smoothly.
  4. Make sure the temperature rises at a rate of no more than 2 K/min.
  5. Flush the pump for approx. 1 minute with pumped liquid to remove residues from the inside of the pump.
  6. After the first load under pressure and at operating temperature, check that the pump is not leaking.
  7. If present, set a slight leak (5 – 6 drops/min.) at the stuffing box.

### 6.1.7 Switching off

## ⚠ WARNING

### Risk of injury due to hot pump parts!

- ▶ Use personal protective equipment when carrying out any work on the pump.

## NOTE

### Material damage due to deposits!

- ▶ If the pumped liquid has crystallized, polymerized or solidified
    - Flush the pump
    - Ensure that the flushing medium is compatible with the pumped liquid
1. Switch off the motor.
  2. If there is no non-return fitting in the pressure line: close the pressure-side fitting.
  3. If necessary: Flush and empty the pump.
  4. Check all connecting bolts and tighten them if necessary.

## 6.2 Operation

### 6.2.1 Switching on

- ✓ Pump initially put into service properly
- ✓ Pump filled and bled

#### DANGER

##### Risk of injury due to running pump or hot pump parts!

- ▶ Do not touch the running pump.
- ▶ Do not carry out any work on the running pump.
- ▶ Allow the pump to cool down completely before starting any work.

#### DANGER

##### Risk of injury and poisoning due to pumped liquid spraying out!

- ▶ Use personal protective equipment when carrying out any work on the pump.

#### NOTE

##### Risk of cavitation when throttling down the suction flow rate!

- ▶ Fully open the suction-side fitting and do not use it to adjust the flow rate.

#### NOTE

##### Material damage caused by dry running!

- ▶ Make sure the pump is filled properly.
1. Open the pressure-side fitting.
  2. Open the suction-side fitting.
  3. Switch on the motor and make sure it is running smoothly.
  4. Make sure the temperature rises at a rate of no more than 2 K/min.

### 6.2.2 Switching off

#### WARNING

##### Risk of injury due to hot pump parts!

- ▶ Use personal protective equipment when carrying out any work on the pump.

#### NOTE

##### Material damage due to deposits!

- ▶ If the pumped liquid has crystallized, polymerized or solidified
    - Flush the pump
    - Ensure that the flushing medium is compatible with the pumped liquid
1. Switch off the motor. Maintain the following functions if present:
    - With double mechanical seals: Blocking pressure until the pump is unpressurized
  2. If there is no non-return fitting in the pressure line: close the pressure-side fitting.
  3. If necessary: Flush and empty the pump.



## 6.3 Shutting down the pump

### WARNING

**Risk of injury and poisoning due to hazardous pumped liquids!**

- ▶ Safely collect any leaking pumped liquid and dispose of it in accordance with environmental rules and requirements.
- 
- ▶ Take the following measures whenever the pump is shut down:

Pump is	Measure
...shut down for a prolonged period	▶ Perform appropriate measures for the pumped liquid (→ Table 9 Measures depending on the behavior of the pumped liquid, Page 25).
...emptied	▶ Close the suction-side and pressure-side fittings.
...dismounted	▶ Isolate the motor from its power supply and secure it against unauthorized switch-on.
...put into storage	▶ Observe the storage instructions (→ 4.3 Storage, Page 16).

Tab. 8 Measures to be taken if the pump is shut down

Behavior of the pumped liquid	Duration of shutdown (depending on process)	
	Short	Long
Sediments, crystallizes, polymerizes or solidifies	▶ Flush the pump	▶ Flush the pump
Solidifying/freezing, non-corrosive	▶ Heat up or empty the pump and containers.	▶ Empty the pump and containers.
Solidifying/freezing, corrosive	▶ Heat up or empty the pump and containers.	▶ Empty the pump and containers. ▶ Treat the pump and containers with preservative.
Remains liquid, non-corrosive	–	–
Remains liquid, corrosive	–	▶ Empty the pump and containers. ▶ Treat the pump and containers with preservative.

Tab. 9 Measures depending on the behavior of the pumped liquid

## 6.4 Start-up following a shutdown period

1. If the pump is shut down for over 6 months, take the following measures before starting it up again:
  - Replace the elastomer seals (O-rings, shaft seal rings).
  - If necessary: Replace the motor bearing (→ operating manual of the motor manufacturer).
2. Carry out the same steps as for the initial start-up (→ 6.1 Putting the pump into service for the first time, Page 22).

## 6.5 Operating the stand-by pump

- ✓ Stand-by pump filled and bled
- ▶ Operate the stand-by pump at least once a week.

## 7 Maintenance

 Trained service technicians are available for fitting and repair work.

Present a pumped liquid certificate (DIN safety data sheet or safety certificate) when requesting service.

### DANGER

#### Risk of death and material damage due to magnetic field!

- ▶ Make sure that personnel who have a pacemaker fitted do not perform any work on the pump.
- ▶ Secure the work area. If necessary isolate the area:
  - Make sure that personnel with pacemakers keep a safe distance of at least 1 meter.
  - Make sure that no magnetizable metal parts can be attracted by the magnetic coupling of the pump.
  - Make sure that parts of the magnetic coupling cannot be attracted by the magnetizable metal parts.
- ▶ Keep all magnetically-sensitive objects at a safe distance of at least 150 mm from the magnetic coupling.

### DANGER

#### Risk of injury due to running pump or hot pump parts!

- ▶ Do not touch the running pump.
- ▶ Do not carry out any work on the running pump.
- ▶ Allow the pump to cool down completely before starting any work.

### WARNING

#### Risk of injury and poisoning due to hazardous pumped liquids!

- ▶ Use personal protective equipment when carrying out any work on the pump.

## 7.1 Inspections

 The inspection intervals depend on the operational strain on the pump.

1. Check at appropriate intervals:
  - Normal operating conditions unchanged
  - Check whether the safety valve is working
2. For trouble-free operation, always ensure the following:
  - No dry running
  - No leaks
  - No cavitation
  - Suction-side fittings open
  - Unclogged and clean filters
  - No unusual running noises or vibrations
  - No excessive leakage at the shaft seal
  - Proper functioning of auxiliary systems

## 7.2 Maintenance

### DANGER

#### Risk of electrocution!

- ▶ Have all electrical work carried out by qualified electricians only.

### 7.2.1 Mechanical seals

 Mechanical seals have functional leaks (→ manufacturer's specifications).

Single mechanical seals with quenching: Any drastic rise in the level of the quenching system indicates a major leak at the mechanical seal.

Double mechanical seals: Any drastic pressure drop in the blocking system (loss of blocking fluid) indicates a major leak at the product-side mechanical seal.

- ▶ In the event of a larger leak: Replace the mechanical seal and its auxiliary seals and check the integrity of the auxiliary systems.

### 7.2.2 Stuffing box

 The stuffing box must always leak slightly to carry the frictional heat away.

Larger leaks in the initial hours of operation lessen during the running-in period.

- ▶ If there is increased leakage: Gently tighten the hexagon nuts on the stuffing box flange.

### 7.2.3 Cleaning the pump

#### NOTE

#### High water pressure or spray water can damage bearings!

- ▶ Do not clean bearing areas with a water or steam jet.
- ▶ Clean large-scale grime from the pump.

## 7.3 Repairs

### DANGER

#### Risk of electrocution!

- ▶ Have all electrical work carried out by qualified electricians only.

### WARNING

#### Risk of injury due to heavy components!

- ▶ Pay attention to the component weight. Lift and transport heavy components using suitable lifting gear.
- ▶ Set down components safely and secure them against overturning or rolling away.

### 7.3.1 Dismounting the pump

- ✓ Pump depressurized
- ✓ Pump completely empty, flushed and decontaminated
- ✓ Electrical connections disconnected and motor secured against being switched on again
- ✓ Pump cooled down
- ✓ Auxiliary systems shut down, depressurized and emptied
- ✓ Pressure gauge lines, pressure gauge and holdings dismantled

### WARNING

#### Risk of injury during disassembly!

- ▶ Secure the pressure-side fitting against accidental opening.
- ▶ Wear protective gloves as components can become very sharp through wear or damage.
- ▶ Remove spring-loaded components carefully (e.g. mechanical seal, tensioned bearing, valves etc.), as components can be ejected by the spring tension.
- ▶ Observe the manufacturer's specifications (e.g. for the motor, coupling, mechanical seal, blocking pressure system, cardan shaft, drives, belt drive etc.).

1. Observe the following during removal:
  - Mark the precise orientation and position of all components before dismantling them.
  - Dismount components concentrically without canting.
2. Dismount the pump (→ sectional and exploded drawing).

### 7.3.2 Returning the pump to the manufacturer

- ✓ Pump depressurized
  - ✓ Pump completely empty
  - ✓ Electrical connections disconnected and motor secured against being switched on again
  - ✓ Pump cooled down
  - ✓ Auxiliary systems shut down, depressurized and emptied
  - ✓ Pressure gauge lines, pressure gauge and holdings dismantled
1. Enclose a truthfully and fully completed clearance certificate when returning pumps or components to the manufacturer (→ 9.4 Clearance certificate, Page 48).
  2. Take necessary measures, depending on the required repair work, as listed in the table below when returning the pump to the manufacturer.

Repairs	Measure for return
...at the customer's premises	▶ Return the defective component to the manufacturer.
...at the manufacturer's premises	▶ Flush the pump and decontaminate it if it was used for hazardous pumped liquids.
...at the manufacturer's premises for warranty repairs	▶ Return the complete pump (not disassembled) to the manufacturer.

Tab. 10 Measures for returning the pump

### 7.3.3 Installing

Install the components concentrically, without canting, in accordance with the markings made.

## NOTE

### Material damage due to unsuitable components!

- ▶ Always replace lost or damaged screws with screws of the same strength.
- ▶ Only replace seals with seals of the same material.

1. Observe the following during installation:
  - Replace worn parts with genuine spare parts.
  - Replace seals, inserting them in such a way that they are unable to rotate.
  - Adhere to the prescribed tightening torques (→ 9.2.5 Tightening torques, Page 41).
2. Clean all parts (→ 9.2.7 Cleaning agents, Page 41). Do not remove any markings that may have been attached.
3. Replace the repair kit.
4. Installing the pump (→ 9.1 Sectional drawings, Page 32).
5. Installing the pump in the system (→ 5 Setup and connection, Page 18).

## 7.4 Ordering spare parts

Keep a complete pump in storage to ensure it can be replaced without problems in the event of damage. Parts which can be replaced can be found in the parts list (→ 9.1.2 MAX® series, Page 34).

- ▶ Have the following information ready to hand when ordering spare parts:
  - Pump type
  - Serial number
  - Year of manufacture
  - Part number
  - Designation
  - Quantity

## 8 Troubleshooting

**⚠ DANGER**

**Risk of death and material damage due to magnetic field!**

- ▶ Make sure that personnel who have a pacemaker fitted do not perform any work on the pump.
- ▶ Secure the work area. If necessary isolate the area:
  - Make sure that personnel with pacemakers keep a safe distance of at least 1 meter.
  - Make sure that no magnetizable metal parts can be attracted by the magnetic coupling of the pump.
  - Make sure that parts of the magnetic coupling cannot be attracted by the magnetizable metal parts.
- ▶ Keep all magnetically-sensitive objects at a safe distance of at least 150 mm from the magnetic coupling.

### 8.1 Pump malfunctions

If malfunctions occur which are not specified in the following table or cannot be traced back to the specified causes, please consult the manufacturer.

Possible malfunctions are identified by a number in the following table. This number identifies the respective cause and remedy in the troubleshooting list.

Fault	Number
Pump not pumping	1
Pumping rate insufficient	2
Pumping rate excessive	3
No pump suction	4
Pump running roughly or clattering	5
Pump jammed	6
Pump leaking	7
Excessive motor power uptake	8

Tab. 11 Fault number assignment

Fault number								Possible cause	Rectification
1	2	3	4	5	6	7	8		
X	-	-	-	-	-	-	-	Transport screw plugs still in place	<ul style="list-style-type: none"> <li>▶ Remove the transport screw plugs.</li> <li>▶ Dismount the pump and inspect it for dry-running damage.</li> </ul>
X	-	-	-	-	-	-	-	Supply/suction pipe closed by fitting	<ul style="list-style-type: none"> <li>▶ Open the fitting.</li> </ul>
X	-	-	-	X	-	-	-	Supply/suction pipe not bled properly or not filled up completely	<ul style="list-style-type: none"> <li>▶ Fill up the pump and/or pipe completely and bleed them.</li> </ul>
X	-	-	-	X	-	-	-	Formation of air pockets in the supply or suction pipe	<ul style="list-style-type: none"> <li>▶ Install the fitting for bleeding.</li> <li>▶ Correct the piping layout.</li> </ul>
X	-	-	-	X	-	-	-	Pressure pipe blocked	<ul style="list-style-type: none"> <li>▶ Clean the pressure pipe.</li> </ul>
X	-	-	X	X	-	-	-	Pump running in the wrong direction	<ul style="list-style-type: none"> <li>▶ Swap any two phases on the motor (→ 5.5.2 Checking the direction of rotation, Page 21).</li> </ul>
X	-	-	X	-	X	-	-	Pump very dirty	<ul style="list-style-type: none"> <li>▶ Dismount and clean the pump.</li> </ul>
X	X	-	X	-	-	-	-	Magnetic coupling broken off	<ul style="list-style-type: none"> <li>▶ Turn off the pump and then turn it back on.</li> <li>▶ Check the operating pressure of the pump if necessary (→ 9.2.1 Pump data, Page 40).</li> <li>▶ If it breaks again, take the pump apart and clean the interior.</li> </ul>
X	X	-	X	X	-	-	-	Supply/suction pipe, pump or suction strainer blocked or encrusted	<ul style="list-style-type: none"> <li>▶ Clean the supply/suction pipe, pump or suction strainer.</li> <li>▶ Clean the suction strainer.</li> </ul>
X	X	-	X	X	-	-	-	Air is sucked in	<ul style="list-style-type: none"> <li>▶ Seal the source of malfunction.</li> </ul>
X	X	-	X	X	-	-	-	Excessive amount of gas: Pump is cavitating	<ul style="list-style-type: none"> <li>▶ Check the cable gland.</li> <li>▶ Clean/enlarge the filter.</li> <li>▶ Enlarge the supply/suction pipe cross-section.</li> </ul>
X	X	-	X	X	-	-	-	Excess play between: <ul style="list-style-type: none"> <li>• Gears</li> <li>• Gears and housing</li> </ul>	<ul style="list-style-type: none"> <li>▶ Repair or replace any worn parts.</li> </ul>
-	X	-	X	-	-	-	-	Motor speed too low	<ul style="list-style-type: none"> <li>▶ Compare the required motor speed with the specifications on the pump type plate. Replace the motor if necessary.</li> <li>▶ Increase the motor speed if speed control is available.</li> </ul>
-	X	-	X	-	-	-	-	Supply/suction pipe not fully opened	<ul style="list-style-type: none"> <li>▶ Open the fitting.</li> </ul>
-	X	-	X	X	-	-	-	Supply/suction pipe cross-section too narrow	<ul style="list-style-type: none"> <li>▶ Enlarge the supply/suction pipe cross-section.</li> <li>▶ Remove any encrustations from the suction pipe.</li> <li>▶ Open the fitting completely.</li> </ul>
-	X	-	X	X	-	-	-	Suction height excessive: $NPSH_{pump}$ larger than $NPSH_{system}$	<ul style="list-style-type: none"> <li>▶ Increase the suction pressure or suction head.</li> <li>▶ Consult the manufacturer.</li> </ul>

Fault number								Possible cause	Rectification
1	2	3	4	5	6	7	8		
-	X	-	X	X	-	-	-	Pumped liquid temperature too high: Pump is cavitating	<ul style="list-style-type: none"> <li>▶ Increase the suction pressure or suction head.</li> <li>▶ Lower the temperature.</li> <li>▶ Consult the manufacturer.</li> </ul>
-	X	-	X	X	-	-	-	Hydraulic parts of the pump dirty, clotted or encrusted	<ul style="list-style-type: none"> <li>▶ Dismount the pump.</li> <li>▶ Clean the parts.</li> </ul>
-	X	-	X	-	-	-	X	Viscosity or specific weight of the pumped liquid outside the range specified for the pump	<ul style="list-style-type: none"> <li>▶ Consult the manufacturer.</li> </ul>
-	-	-	-	X	-	-	-	Pressure-side fitting not opened wide enough	<ul style="list-style-type: none"> <li>▶ Open the pressure-side fitting.</li> </ul>
-	X	-	X	X	X	-	-	Pump parts worn	<ul style="list-style-type: none"> <li>▶ Replace the worn pump parts.</li> </ul>
-	-	X	-	X	-	-	X	Motor speed too high	<ul style="list-style-type: none"> <li>▶ Compare the required motor speed with the specifications on the pump type plate. Replace the motor if necessary.</li> <li>▶ Reduce the motor speed if speed control is available.</li> </ul>
-	-	-	-	-	-	X	-	Tie bolts not tightened properly	<ul style="list-style-type: none"> <li>▶ Tighten the tie bolts (→ 9.2.5 Tightening torques, Page 41).</li> </ul>
-	-	-	-	-	-	X	-	Mechanical seal worn	<ul style="list-style-type: none"> <li>▶ Replace the mechanical seal.</li> </ul>
-	-	-	-	-	-	X	-	Housing seal defective	<ul style="list-style-type: none"> <li>▶ Replace the housing seal.</li> </ul>
-	-	-	-	X	X	X	X	Pump distorted	<ul style="list-style-type: none"> <li>▶ Check the pipe connections and pump attachment.</li> </ul>
-	X	-	X	X	-	-	X	Motor running on 2 phases	<ul style="list-style-type: none"> <li>▶ Check the fuse and replace it if necessary.</li> <li>▶ Check the cable connections and insulation.</li> </ul>

Tab. 12 Pump troubleshooting list

## 9 Appendix

### 9.1 Sectional drawings

#### 9.1.1 VGP series

##### Parts list

Part no.	Designation
1	Driven shaft
2	Rear housing
3A	Short bearing
3B	Long bearing
4	Housing screw
5	Housing O-ring
6	Driven gearwheel
7	Wear plate
8	Front housing
9	Drain screw 1/8" npt
10	Outer magnet
11	Inner magnet
12	Separating can
13	Shaft key for inner magnet
14	Screw for outer magnet
15	Screw
16	Adapter
17	Grub screw for fixing magnet
18	Screw for separating can
19	O-ring for separating can
20	Driving shaft
21	Middle housing
22	Driving gearwheel
23A	Shaft key for driving gearwheel
23B	Shaft key for driven gearwheel
24	Housing pin
25	Bearing pin
26	Adapter nut
27	Screw for front housing

Part no.	Designation
28	Snap ring
29	Housing nut
30	Washer for housing
31	Washer for front housing
32	Washer for separating can
33	Magnet hub for outer magnet
34	Adapter washer

Tab. 13 Designation of components (VGP series)



## Sectional drawings

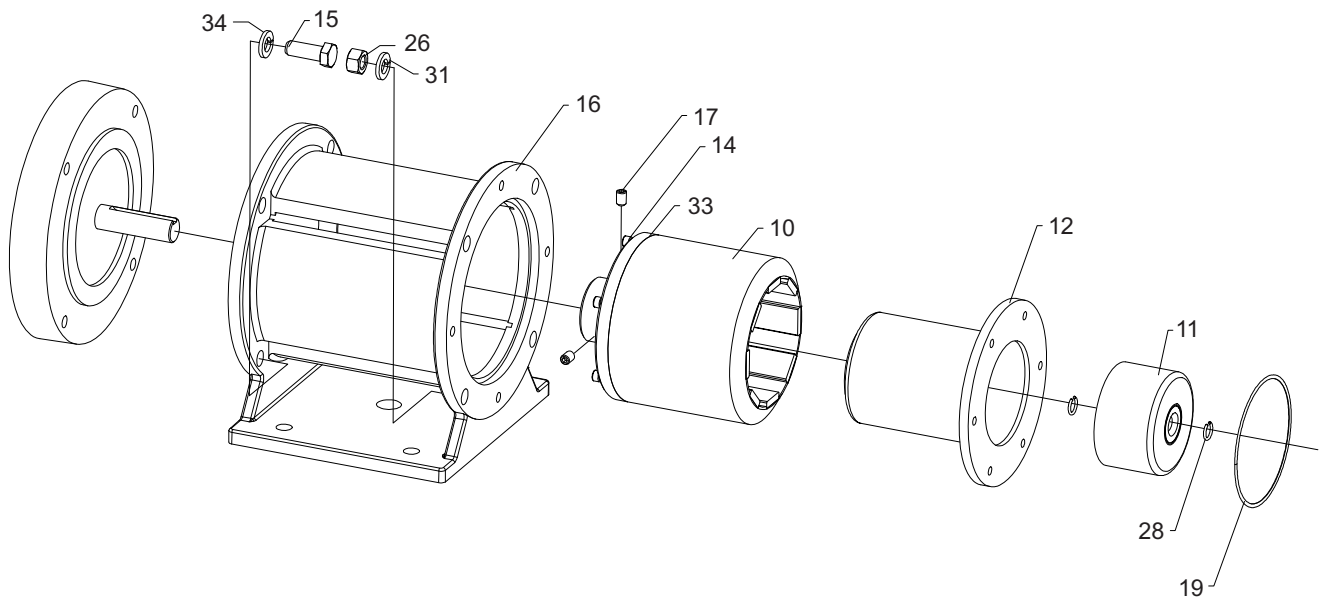

Fig. 8 Sectional drawing of magnetic coupling (VGP series)

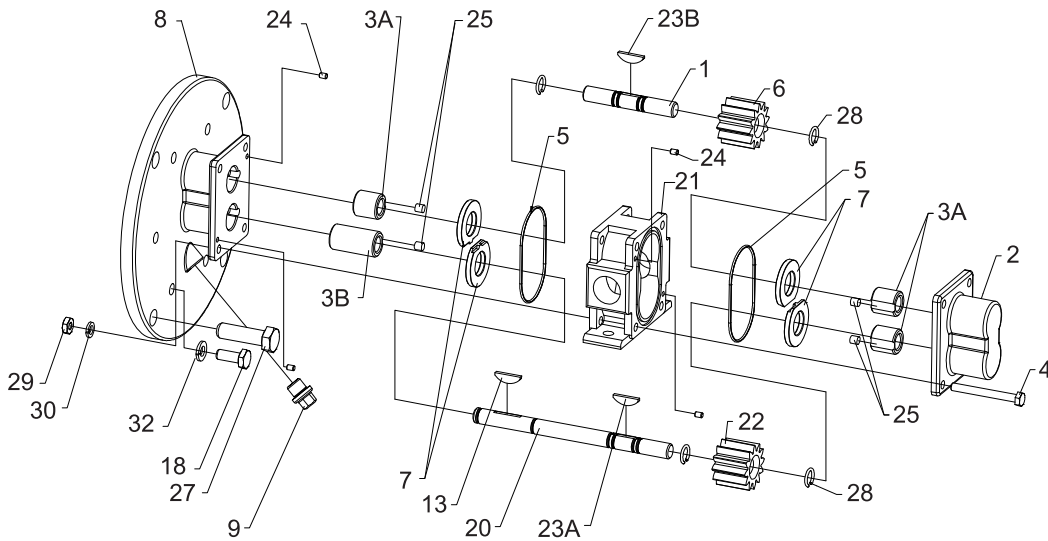

Fig. 9 Sectional drawing of pump (VGP series)

### 9.1.2 MAX<sup>®</sup> series

#### Parts list

Part no.	Designation
1	Driven shaft
2	Rear housing
3	Bearing
4	Housing screw
5	Housing O-ring
6	Driven gearwheel
7	Wear plate
8	Front housing
9	Motor
10	Outer magnet
11	Inner magnet
12	Magnet can
13	Shaft key for inner magnet
14	Screw
15	Motor screw
16	Adapter
17	Grub screw for fixing magnet
18	Screw for separating can
19	O-ring for separating can
20	Driving shaft
21	Middle housing
22	Driving gearwheel
23	Shaft key for gearwheel
24	Bearing pin
25	Housing nut
26	Housing screw
27	Snap ring
28	Housing pin
29	Housing washer
30	Hub, outer magnet

Tab. 14 Designation of components (MAX<sup>®</sup> series)

Sectional drawings

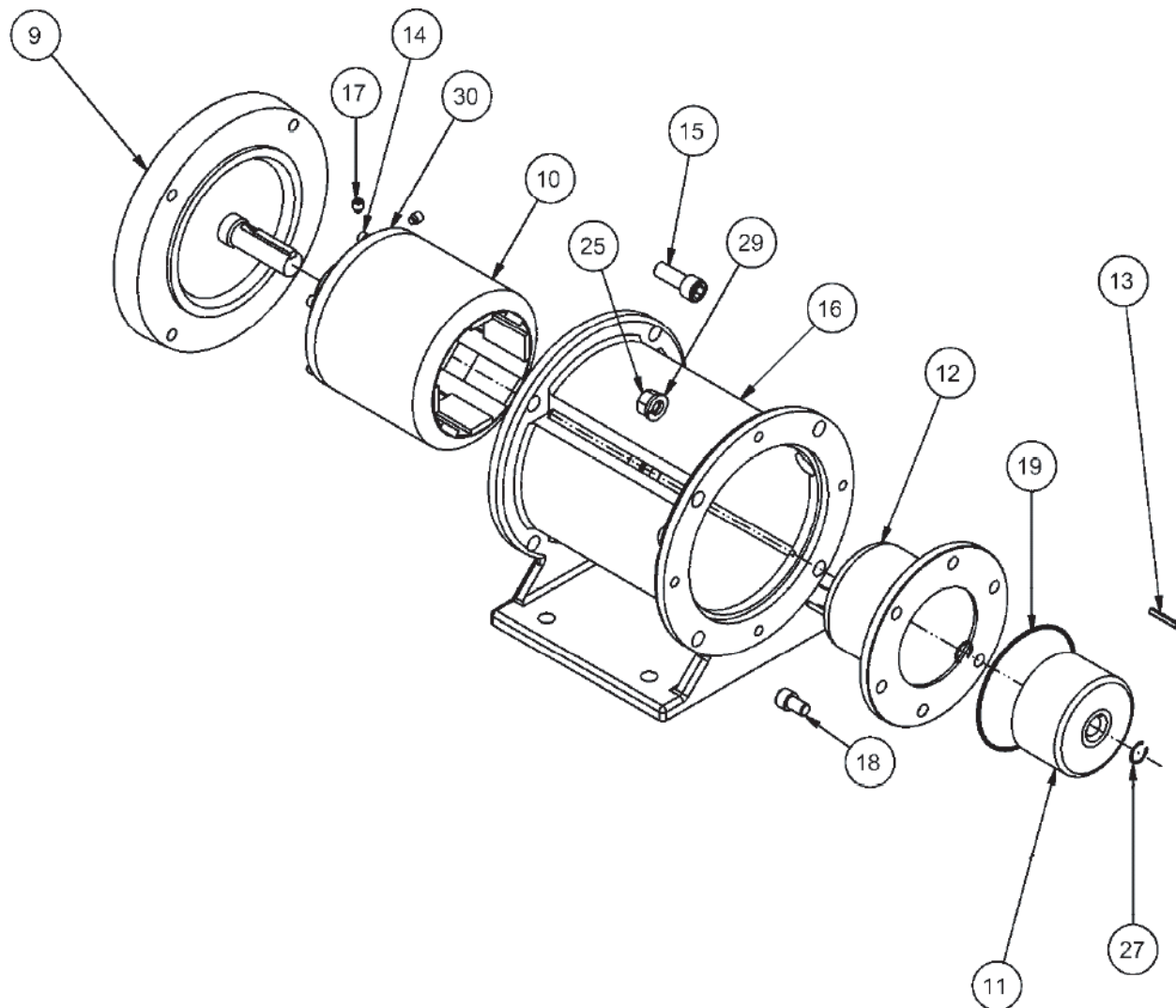

Fig. 10 Sectional drawing of magnetic coupling (MAX® series)

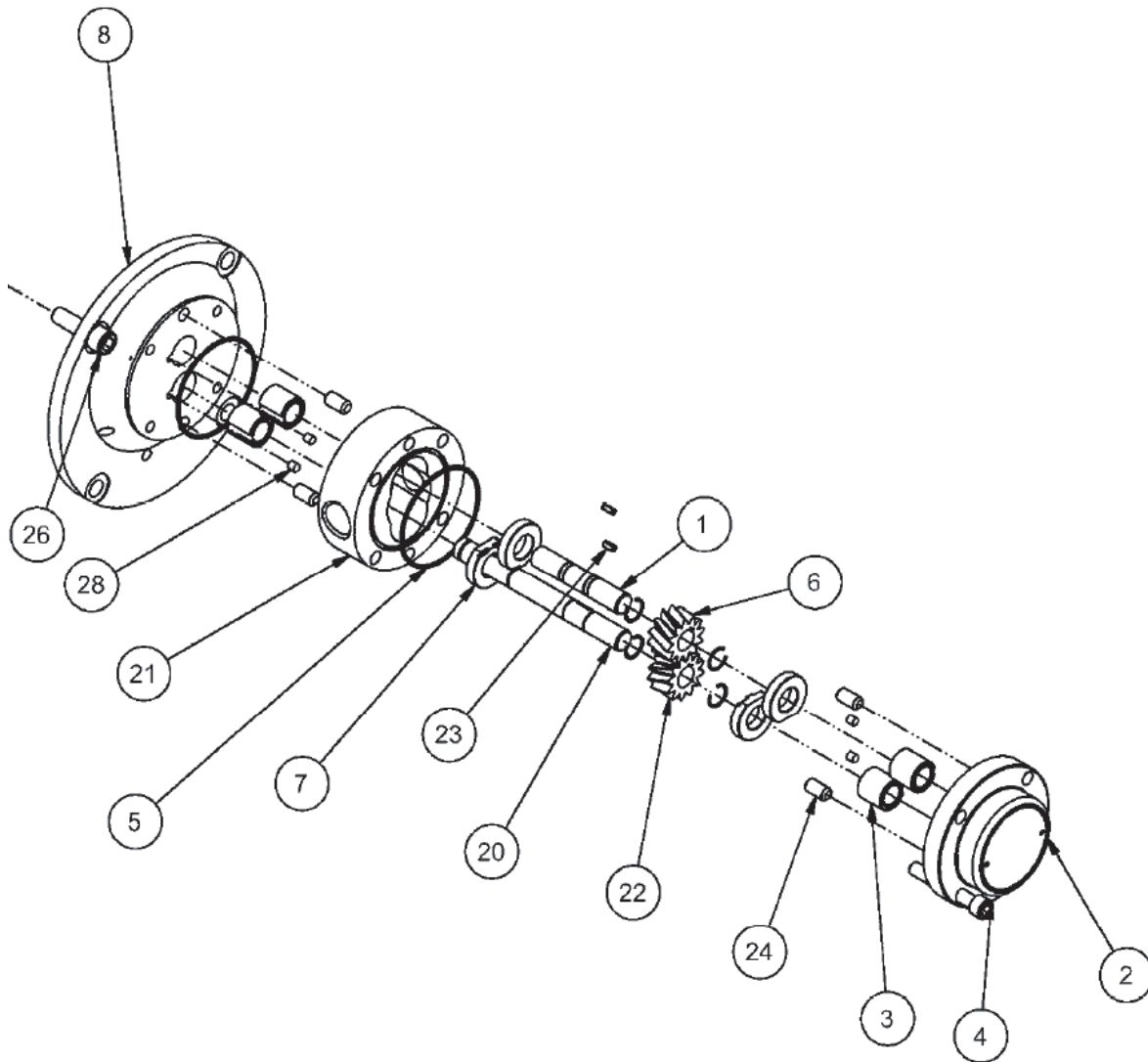

Fig. 11 Sectional drawing of pump (MAX® series)

### 9.1.3 Version with mechanical seal

#### Parts list

Part no.	Designation
1	Driven shaft
2	Rear housing
3A	Short bearing
3B	Long bearing
4	Housing screw
5	Housing O-ring
6	Driven gearwheel
7	Wear plate
8	Front housing
9	Plug 1/8" npt
10	Housing nut
11	Single/double mechanical seal
12	Housing pin
13	Bearing pin
14	Snap ring
15	Washer for housing
16	Screw for seal disk
17	Seal disk
18	Seal ring for seal seat
19	Screw washer for seal disk
20	Driving shaft
21	Middle housing
22	Driving gearwheel
23A	Shaft key for driving gearwheel
23B	Shaft key for driven gearwheel
24	External seal seat
27	O-ring for sealing plate
28	Sealing plate
29	Screw for sealing plate
30	Washer for sealing plate
31	Screw for front housing
32	Washer for front housing
33	Nut for front housing
34	Adapter
35	Coupling guard
36	Screw for coupling guard

Part no.	Designation
37	Coupling half
38	Coupling connection
39	Setting screw for coupling
40	Adapter plug
41	Screw for motor connection
42	Screw washer for motor connection
46	Motor
47	Slot nut

Tab. 15 Designation of components (MAX<sup>®</sup> series)

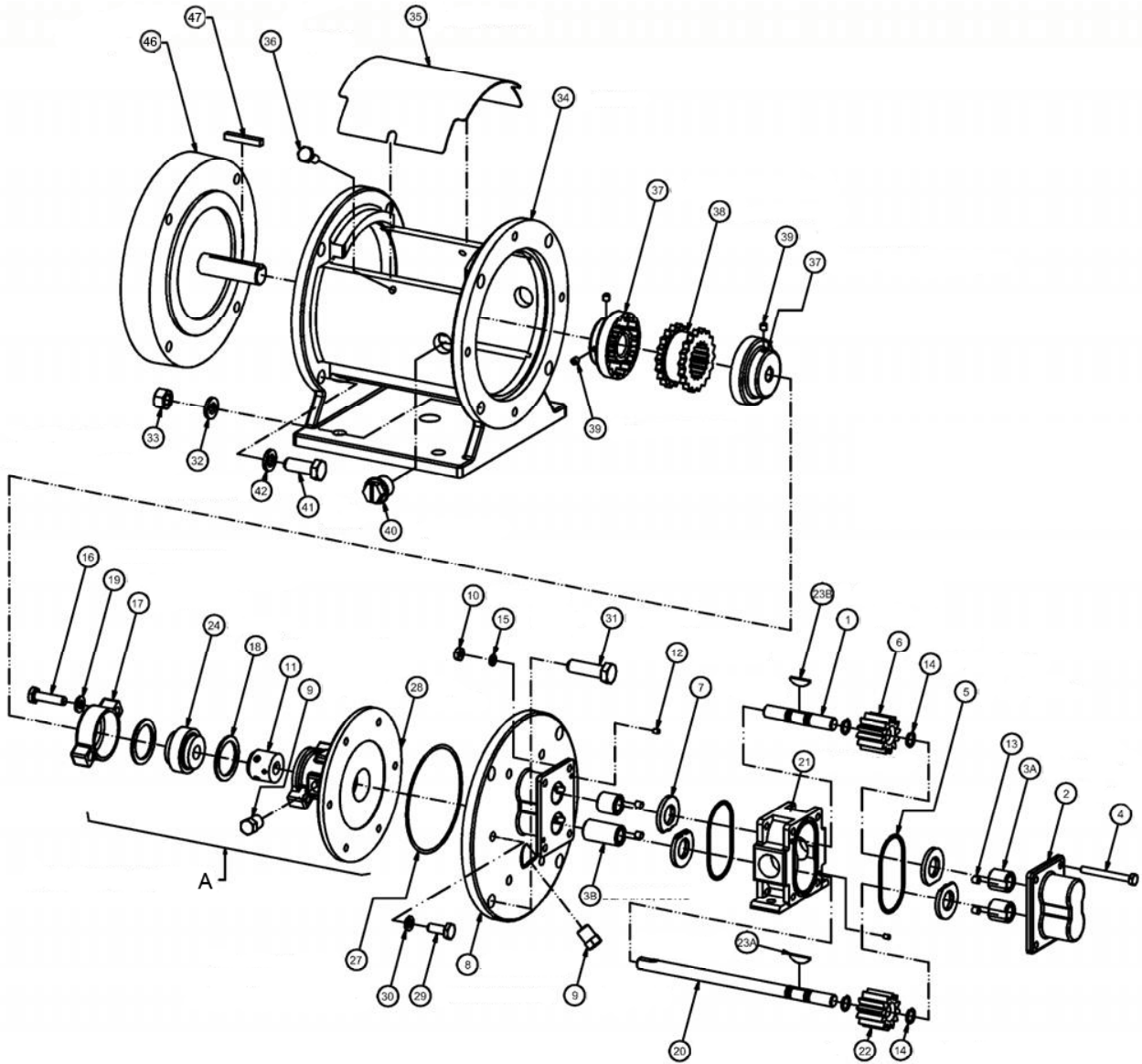

Fig. 12 Sectional drawing of version with mechanical seal (MAX<sup>®</sup> series)

A Version with single mechanical seal

## 9.1.4 Versions

### Parts list

Part no.	Designation
11	Single/double mechanical seal
17	Seal disk
18	Seal ring for seal seat
24	External seal seat
25	Internal seal seat
26	Seal ring for internal seal seat
43	Stuffing box
44	Retaining ring
45	Lubrication plug

Tab. 16 Designation of components (MAX® series)

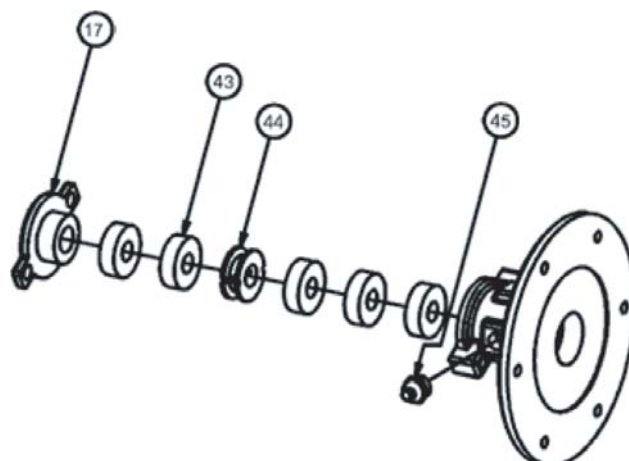

Fig. 13 Version with stuffing box

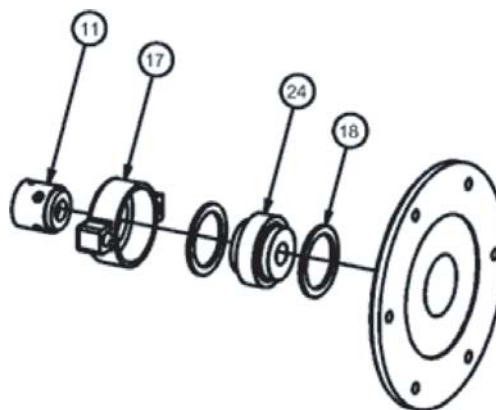

Fig. 14 Version with external mechanical seal

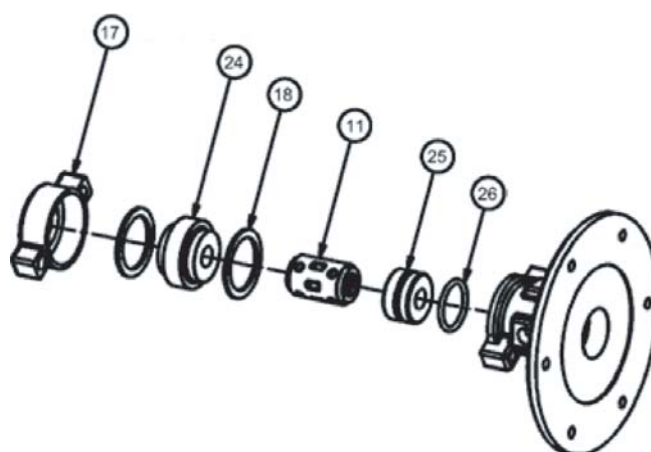

Fig. 15 Version with double mechanical seal

## 9.2 Technical specifications

### 9.2.1 Pump data

Size	Value
Max. differential pressure (suction side to pressure side)	7 bar – 24 bar 3.5 bar for pumps with Teflon mechanical seal
Max. system pressure	15.5 bar – 34 bar
Pumped liquid Viscosity	Max. 100,000 mPas (mm <sup>2</sup> /s)
Median temperature	< 260 °C
Motor speed	Max. 1,750 rpm
Dimensions	→ dimensions sheet

Tab. 17 Pump data

### 9.2.2 Ambient conditions

 Operation under any other ambient conditions should be agreed with the manufacturer.

#### Operating conditions

- Ambient temperature -20 °C to +40 °C
- Relative humidity
  - Long-term ≤ 85 %
  - Briefly ≤ 100 %
- Setup height above sea level ≤ 1000

#### Storage conditions

- Ambient temperature +10 °C to +50 °C
- Relative humidity
  - Long-term ≤ 85 %
  - Briefly ≤ 100 %

### 9.2.3 Parameters for auxiliary systems

#### Blocking medium, double mechanical seal

	Volume [l/h]	Pressure
Flushing	200 - 300	1 bar above pressure at the shaft seal
Blocking	100 - 200	1 bar above pressure at the shaft seal

Tab. 18 Operating parameters for blocking medium

#### Sealing medium in open flow system, single mechanical seal

	Volume [l/h]	Pressure
Quenching	150	Depressurized
Blocking	150	1 bar above the pump output pressure

Tab. 19 Operating parameters for sealing medium

### 9.2.4 Sound pressure level

Sound pressure level < 75 dB(A)

Measuring conditions:

- Speed 1,000 rpm
- Operating pressure 2 bar
- Operating temperature 20 °C
- Pumped liquid 1 cSt, non-lubricating



### 9.2.5 Tightening torques

 The following values apply to oiled screws and torque tightening processes.

Series	Thread size	Quality	Tightening torque [Nm]
Housing			
H1F, H3F, 31F, 33F	10-32 UNF, 1 1/2	18/8, stainless steel	3.5
H5R, H5F, 35R, 35F	10-32 UNF, 1.80		3.5
H7N, H7R, 37R	1/4-20 UNC, 2 1/4		8.5
H7F, 37F	1/4-20 UNC, 2 1/2		8.5
H9R, 39R	1/4-20 UNC, 3		8.5
H9F, 39F, 311F	1/4-20 UNC, 3 3/4		8.5
Other			
Containment can H1F - H9F, 31F - 39F, 311F	1/4-28 UNF 5/8	18/8, stainless steel	10.6
Pump foot H1F - H9F, 31F - 39F, 311F	3/8-16 UNC 1 1/4		26.7
Motor foot H1F - H9F, 31F - 39F, 311F	3/8-16 UNC 1		26.7
Motor adapter H1F - H9F, 31F - 39F, 311F	1/2-13 UNC 1		58.4
Pedestal adapter H1F - H9F, 31F - 39F, 311F	3/8-16 UNC 1		26.7

Tab. 20 Tightening torques

### 9.2.6 Preservatives

 Use RUST-BAN 335 as a preservative, for example.

### 9.2.7 Cleaning agents

Application area	Cleaning agents
Other	Benzine, wax solvents, diesel, paraffin, alkaline cleaners

Tab. 21 Cleaning agents

### 9.3 Performance curves

#### H1

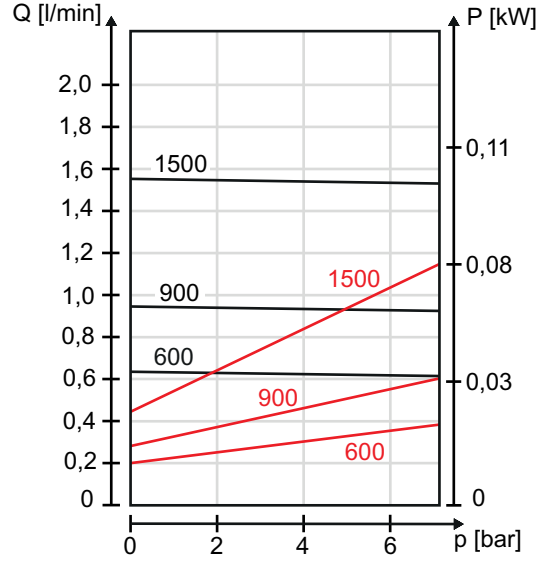
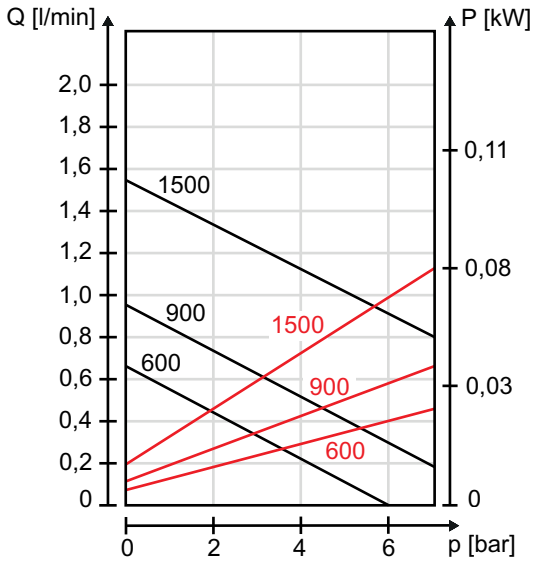

#### H3

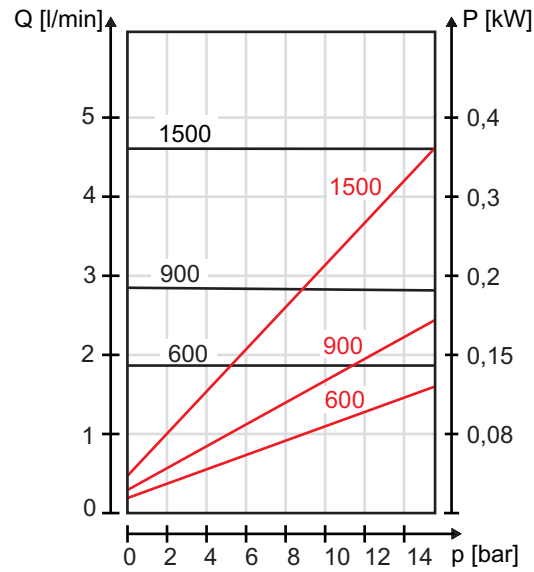
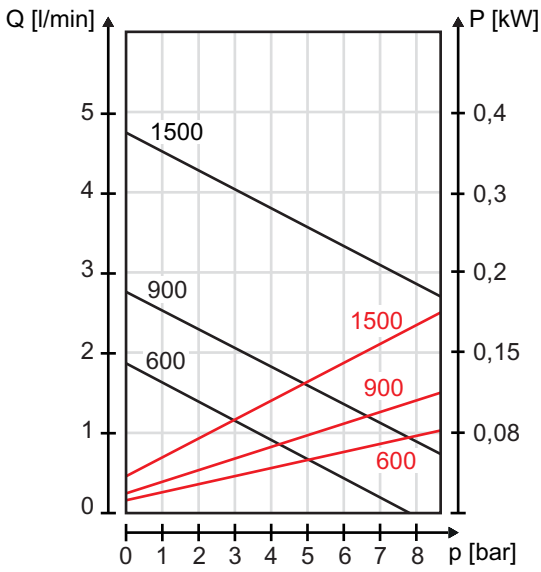

## H5R

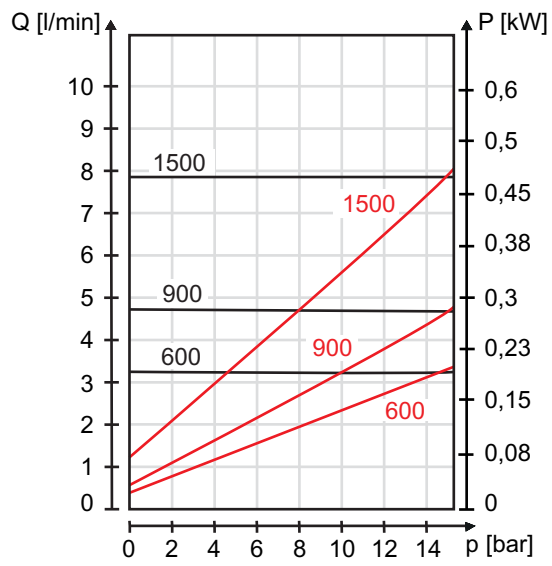
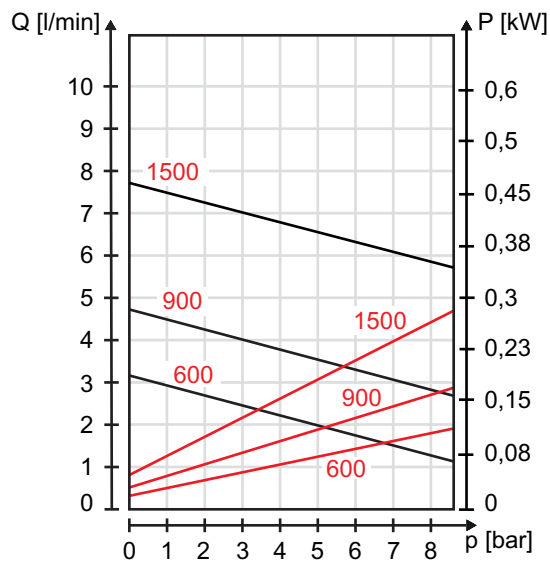

## H5F

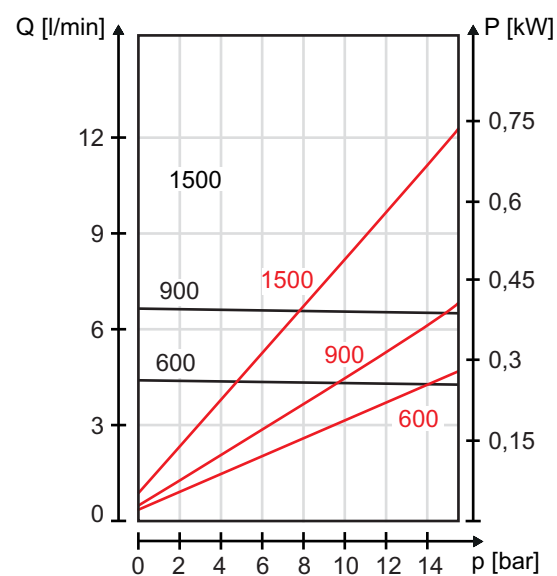
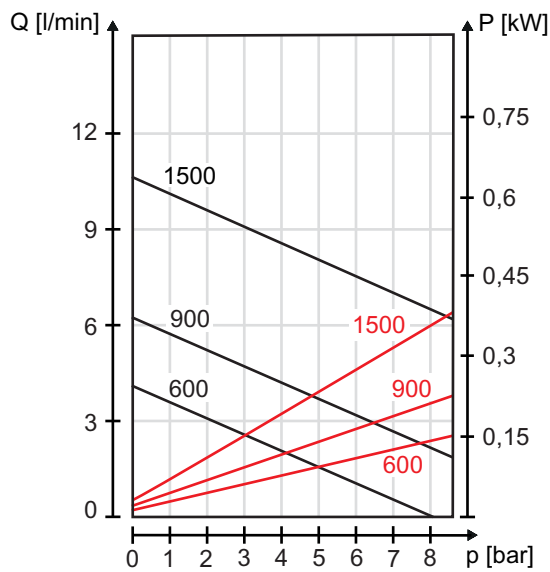

**H7R**

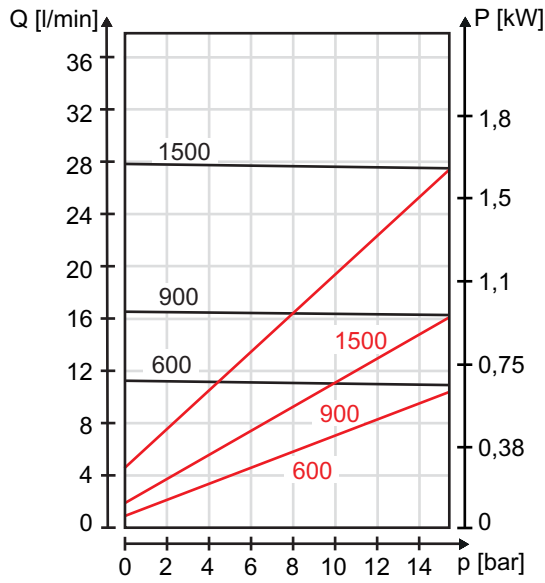
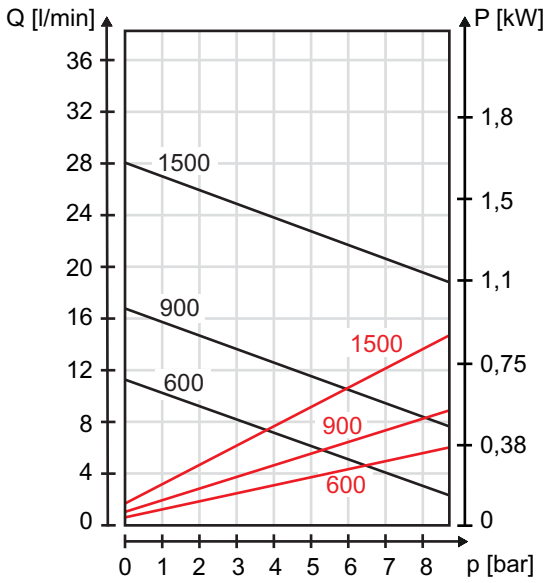

**H7F**

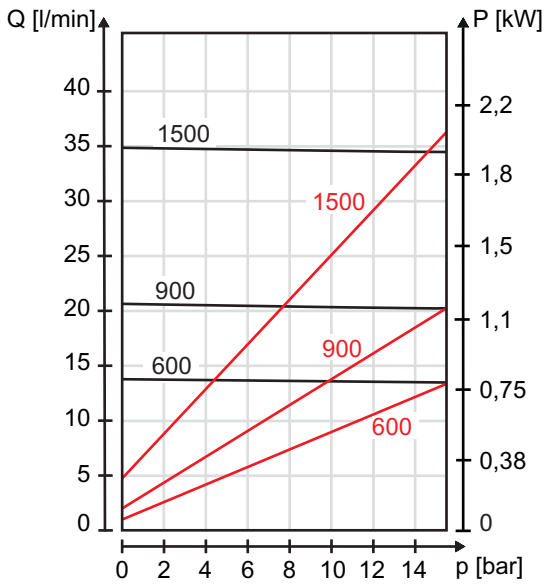
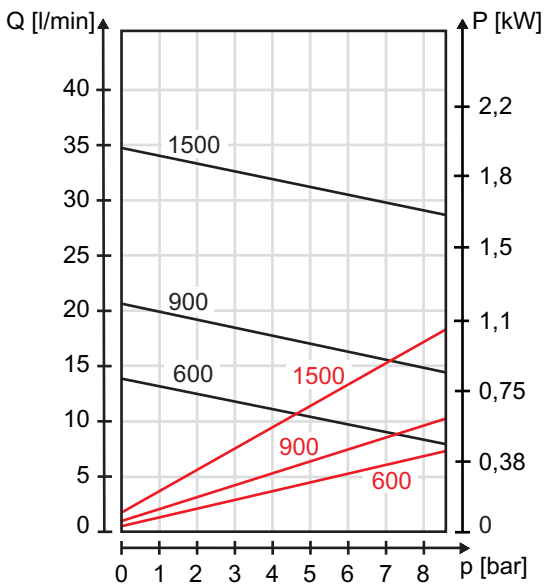

## H9R

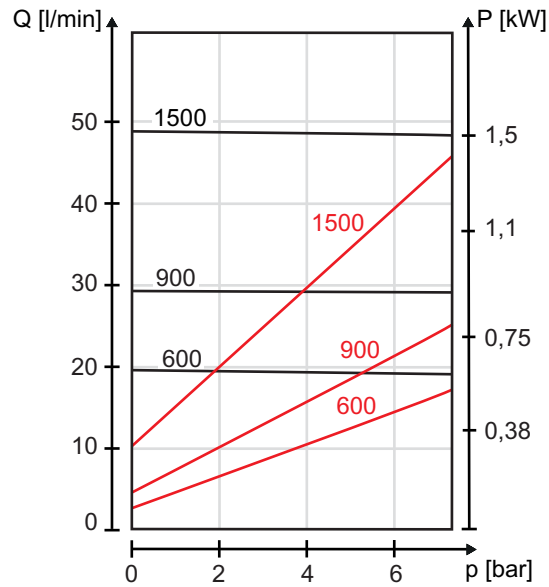
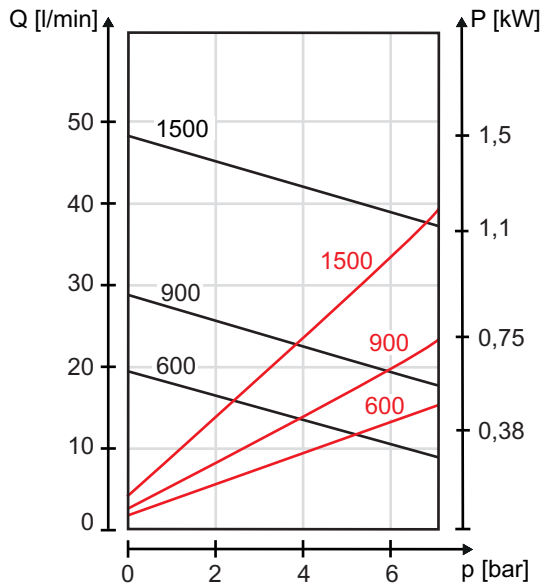

## H9F

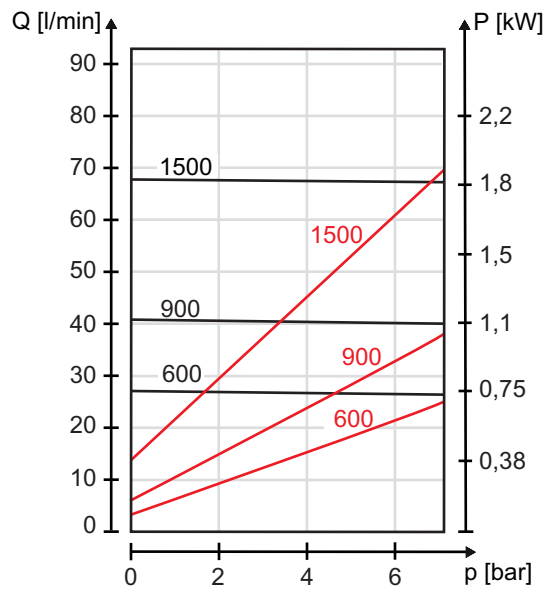
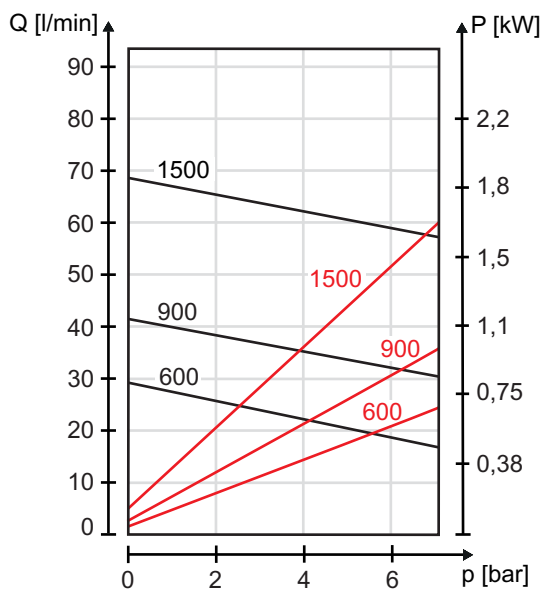

**H12R**

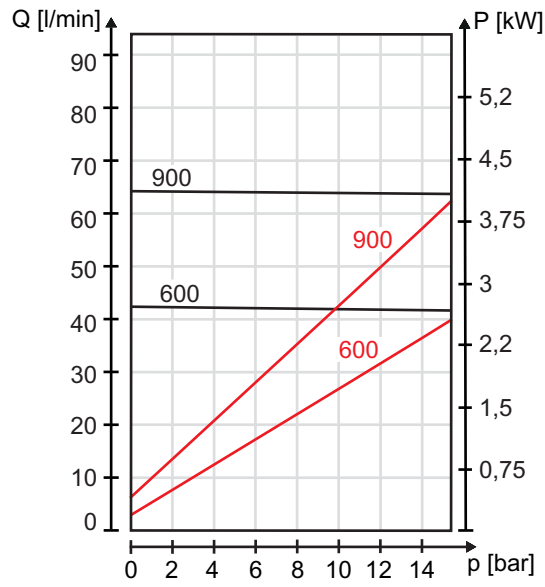
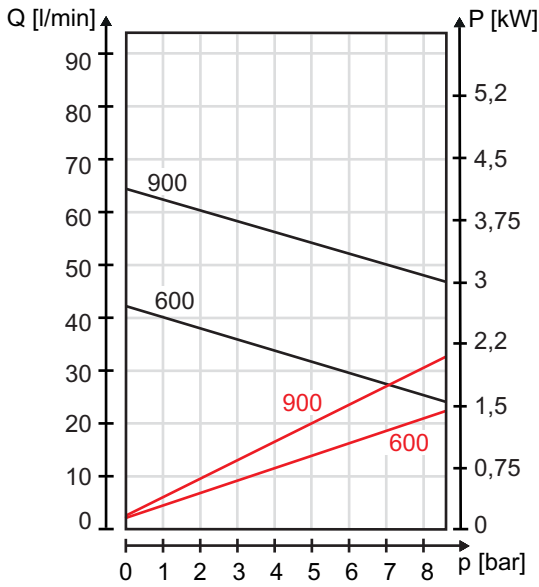

**H12F**

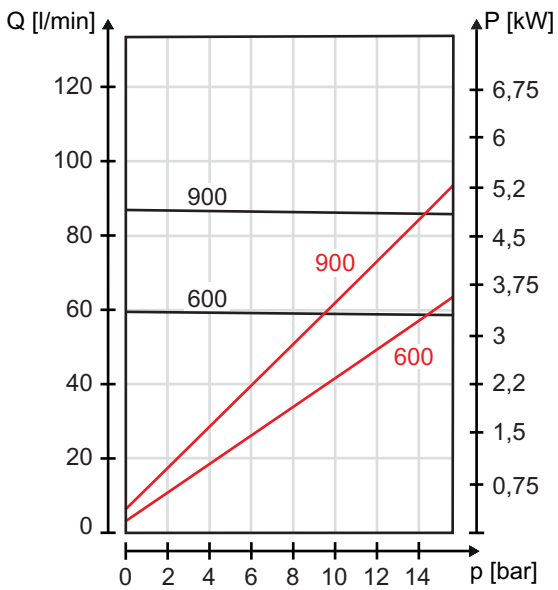
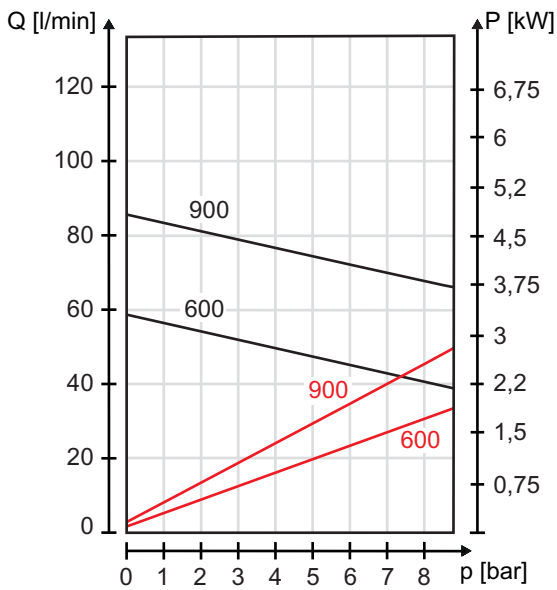

## 314F

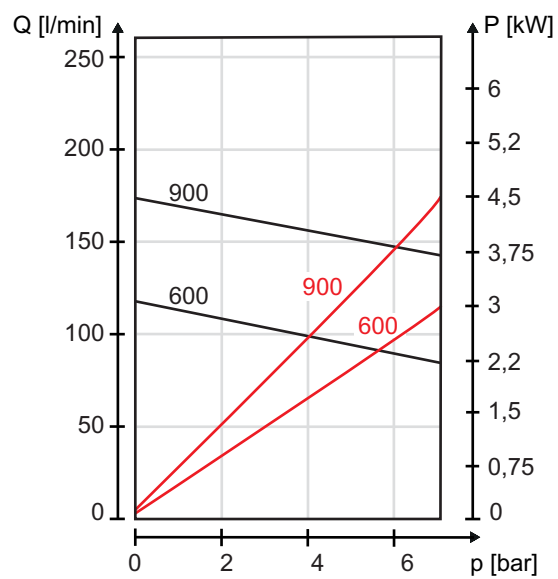
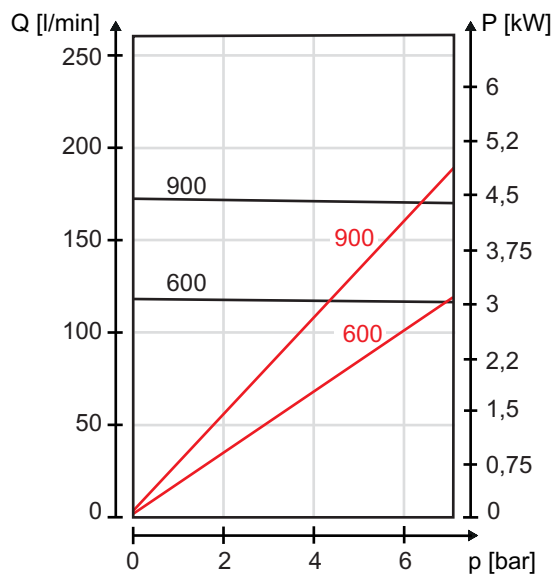

## 9.4 Clearance certificate

 Please copy this document and send it together with the pump.

The pump and accessories submitted for inspection / repairs together with the safety certificate by us, the signatory:	
Type: _____	Delivery date: _____
Part no.: _____	Order no.: _____
Reason for inspection / repair: _____	
<p><input type="checkbox"/> Was not used with liquids that are hazardous to health or the environment.</p> <p><input type="checkbox"/> Was used for the following application: _____          Came into contact with liquids that must be labeled for safety or are considered to be polluting.</p> <p><input type="checkbox"/> Last pumped liquid: _____</p> <p><input type="checkbox"/> The pump has been carefully emptied and cleaned on the outside and inside prior to delivery or provision.</p> <p><input type="checkbox"/> Special safety precautions are not necessary for subsequent handling.</p> <p><input type="checkbox"/> The following safety precautions regarding rinsing liquids, liquid residue and disposal are necessary: _____</p>	
<p> If the pump was used with critical liquids, make sure you enclose a <b>safety data sheet</b> in the package.</p>	
We hereby declare that the information given is correct and complete, and that the pump is being shipped in accordance with legal requirements.	
Company / address: _____	Phone: _____
	Fax: _____
Customer no.: _____	
Name of issuer: (capital letters) _____	Position: _____
Date: _____	Company stamp / signature: _____

Tab. 22 Clearance certificate



## 9.5 Declaration of conformity according to EC Machine Directive

 The following declaration does not contain serial numbers or signatures. The original declaration is delivered with the respective pump.

### Declaration of conformity

<p><b>EC declaration of conformity according to machine directive, appendix II A</b></p> <p>We, VERDER Deutschland GmbH &amp; Co. KG, Retsch-Allee 1 – 5, 42781 Haan, Germany, hereby declare that the following machine adheres to the relevant EC Directives detailed below:</p> <p>Serial number _____</p> <p>Designation      <u>        VGP H1...VGSP H12, MAX<sup>®</sup> M0...M8        </u></p> <p>Order no.                 _____</p> <p>EC Directives:</p> <ul style="list-style-type: none"> <li>• Machine Directive (2006/42/EC)</li> <li>• Low-voltage Directive (2006/95/EC)</li> <li>• EMC Directive (2004/108/EC)</li> </ul> <p>Applicable harmonized norms:</p> <ul style="list-style-type: none"> <li>• EN ISO 12100:2010</li> <li>• EN 60204-1:2011-01</li> </ul>		
<p>Responsible for the documentation</p> <p style="text-align: right; margin-right: 200px;">VERDER Deutschland GmbH &amp; Co. KG Retsch-Allee 1 – 5 42781 Haan</p>		
<p><b>Date:</b> 10/01/2012</p>	<p><b>Company stamp / signature:</b></p> <p style="text-align: center; margin-top: 50px;">Head of Development/Construction</p>	<p><b>Company stamp / signature:</b></p> <p style="text-align: center; margin-top: 50px;">Head of Quality</p>

Tab. 23 Declaration of conformity according to EC Machine Directive

