

VERDERGEAR Small, Gear pump VGS380

Description

Verdergear Gear Pumps are perfectly suitable for demanding applications in fluid transfer for dangerous liquids or expensive chemicals. They produce a very constant pulsation free flow without leakage.

The magnetically driven gear pumps have no shaft seals and are 100% leakfree. The pumps are perfect for dosing small volumes in a precise and reproducible way.



Advantages

- Pulsation free flow
- Highly reliable
- High dosing accuracy
- Corrosion-resistant materials
- Self-priming
- Very user-friendly

Application areas

- Construction industry
- Chemical industry
- Research & Development
- Food industry
- Paper industry
- Textile industry
- Environmental technology

Technical data

Speed range	40 - 5000 Rpm
Flow range	0 - 690 l/h
Max. differential pressure	7 bar
Max. system pressure	34 bar
Temperature range	-46 to +176 °C
Viscosity	1 - 2000 mPas*
Connections	1/4 " NPT (optional 1/8 " NPT)
Noise level	< 70 dB (A)
Material o-ring	PTFE (optional Viton)
Material gears	PEEK (optional PPS)
Material casing	Stainless steel 316L (optional Hastelloy, Titan)

* higher viscosities are possible on request

VERDERGEAR Small, Gear pump VGS380

Flow curve

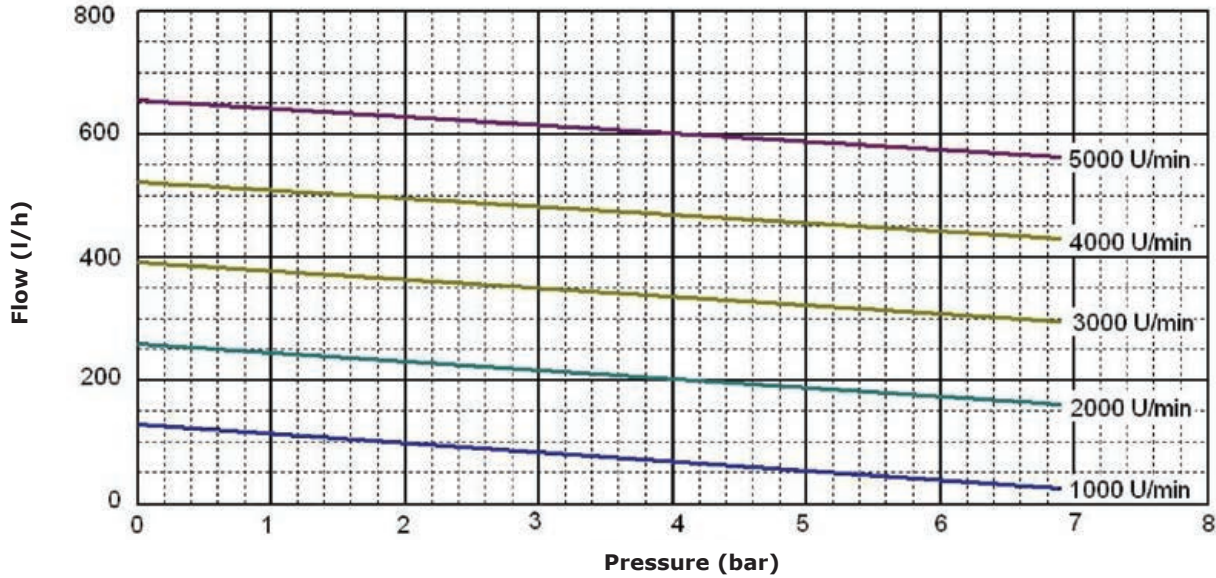

Flow curve valid for suction: 1 bar; media temperature: 20 °C; media viscosity: 1 cSt; bypass valve completely closed

Drawing

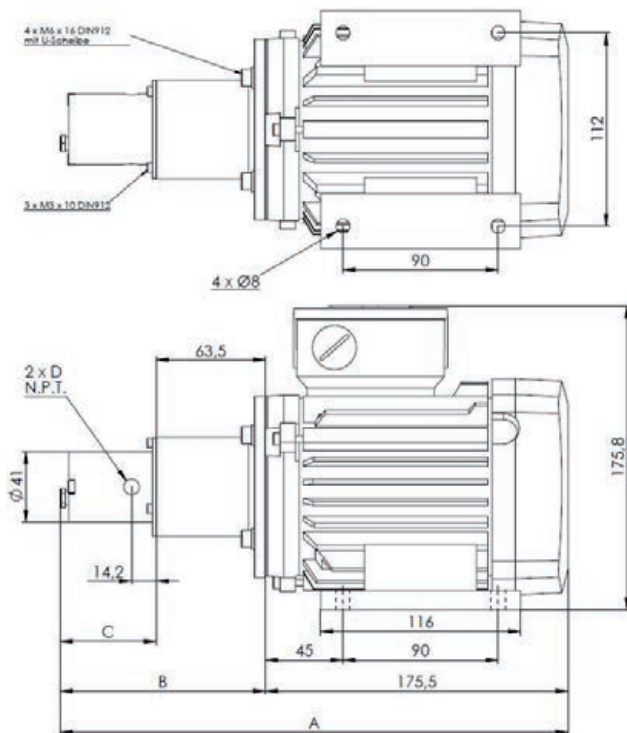

Model	A	B	C	D
VGS380	313.7 mm	138.2 mm	74.7 mm	1/4 "

